

www.cs-france.fr

ACROVYN[®]

WALL PROTECTION AND HANDRAILS

Protecting your interior

Hospitals, Clinics,
Nursing homes,
Kindergartens, Education,
Transport interchanges
Hotels, Fitness centres,
Canteens, Restaurants,
Retail outlets
Pharmaceutical and
Cosmetic industries, etc.

THE STRENGTH OF A LEADER

CS Construction Specialties

WORLD LEADER

For several decades, Construction Specialties, Inc. has been pursuing its innovative approach by giving priority to quality and service.

Our leading position for over 50 years has nothing to do with luck.

It is the result of total commitment to our customers' satisfaction. The C/S Acrovyn® range is available on all continents.

CS France

EUROPEAN LEADER

How to protect walls against impacts?

How to match wall protection with global floor and global interior environment ?

How to ensure hygiene in exposed locations?

QUESTIONS YOU HAVE TO FIND AN ANSWER TO EVERY DAY!



CS France

Company introduction

What a long way the C/S Group has come since launching C/S Acrovyn® in the early seventies!

Here are some examples of major changes:

- New colours (originally 4, currently 30)
- Change in shapes (formerly with angles, now soft)
- A larger number of models to meet all building configurations.
- And now a broad choice of materials responding to environmental and sustainable needs

All these improvements, which have resulted from listening to our customers, have enhanced the C/S Group's unquestionable position as world leader.

Philippe Luguët
Manager

Aerial view of C/S France's factory
at Pacy-sur-Eure



WALL PROTECTION AND HANDRAILS

architecture safety beauty fresco
 fluidity
 material hygiene environment
 geometry design adaptability
 ergonomics
 comfort light colour
 mobility signposting
 layout art fire resistance
 space decoration

Our mission :
 Wall protection combined with leading-edge design

ACRO CONCEPT™

- The concept of architectural protection Page 6
- Product ranges Page 8
- C/S Acrovyn® formulation Page 10
- Ergonomic shapes Page 12
- Colours, finishes and materials Page 14
- C/S Acrovyn® 3000: protect the environment Page 16

ACRO SPACE™

- Open spaces and circulation areas Page 20
- Corridors Page 22
- Emergencies Page 24
- Hospital wards Page 26
- Operating theatres Page 28
- Reception area Page 30
- Lifts / Staircases Page 32
- Cultural centres Page 34
- Fitness centres Page 36
- Education Page 38
- Catering Page 40
- Restaurants Page 42
- Industrial laboratories Page 44
- Retail outlets Page 46
- Hotels Page 48
- Loading bays / logistical centres Page 50
- Transport interchanges Page 52

ACRO ITEMS™

- C/S Acrovyn® Sheet (flat surface protection for doors and walls) Page 58
- C/S Acrovyn® Handrails Page 68
- C/S Acrovyn® Bumper guards Page 70
- C/S Acrovyn® Corner guards Page 73
- C/S Stelatex® Page 74

ACRO SERVICES™

- Our services Page 76

ACRO CONCEPT™

Products that meet all your requirements

C/S Acrovyn® protects interiors and ensures durability.

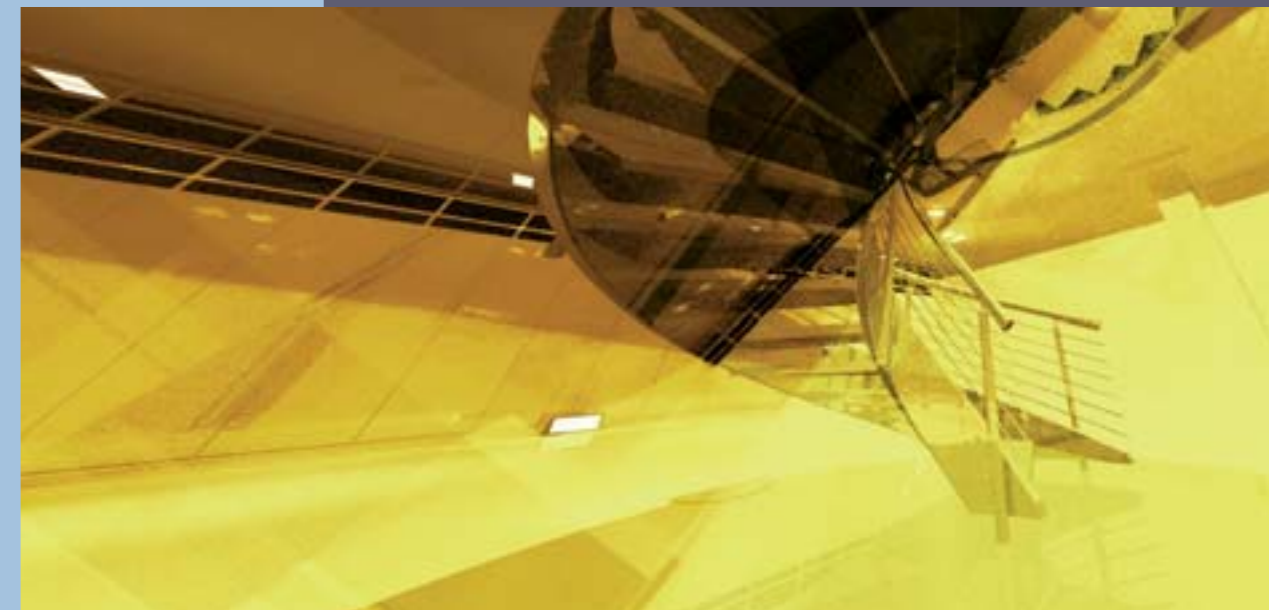

The Acrovyn® concept: wall protection for public buildings.

- The movement of people and equipment causes damage to internal surfaces. Designers and end users are constantly concerned with hygiene and maintenance of the interior.
- Our wall protection concept meets these expectations. C/S Acrovyn® products protect walls, corners, doors and facilitate maintenance. C/S Acrovyn® helps to keep the building in its original condition and allows you to reduce maintenance costs.
- C/S Acrovyn® handrails provide support with enhanced comfort and safety.

With both our techniques and know-how, C/S Acrovyn® handrails provide protection and design to public facilities:

- All types of public buildings that are subject to impact damage.
- All types of buildings where hygiene and maintenance is a priority.
- All types of buildings requiring mobility aids.

Hospitals • Clinics • Nursing homes • Kindergartens • Education • Canteens
 Restaurants • Hotels • Airports • Libraries • Shopping Centres • Fitness centres
 Swimming Pools • Retail outlets • Pharmaceutical and Cosmetic Industries

What we provide...

TO THE CLIENT:

- Permanent solutions
- Reduction of maintenance costs
- Hygiene
- Safety

TO THE MAIN CONTRACTOR:

- Architectural project
- Design
- Technical solution
- Expertise

Working in partnership with the owner and design team.

TO THE INSTALLER:

- Quick and easy installation
- Savings
- Instructions and accessories
- On-site technical assistance

TO CONTROL BODIES:

- Compliance with safety, hygiene and environmental standards
- Certification reports

TO THE USER:

- Pleasant living / working environment
- Safety
- Ergonomic comfort
- Hygiene
- Aesthetics



Product ranges for wall protection and mobility aid

■ C/S Acrovyn® sheets

A complete or mid-wall covering that combines design and protection:

- For application on walls and doors
- Creative freedom
 - Standard shapes offered by C/S
 - Custom design and shapes

■ C/S Handrails

Handrails used as mobility aids in corridors and staircases.

■ C/S Crash rails

Bumper guards positioned at required impact level

■ C/S Corner guards

Protection to cover exposed wall corners.

Proven formulation



In the early 70s, the C/S Group's founder developed the Acrovyn® resin and an innovative wall protection concept.

Acrovyn® is a special formulation based on a vinyl acrylic resin including shock modifiers, fire retardants and UV stabilizers.

Aware of the immense potential, the Company then developed varied shapes and colours as a solution to internal protection problems.

It was a rapid success, particularly in the healthcare sector.

Over recent years, the products developed have been used in various types of buildings.

C/S France carries on its research to create new materials, new products and new colours in order to meet new needs.



ENVIRONMENTAL APPROACH

Aware of the ecological and health concerns, C/S France has decided to apply the European directive 2002/95/CE or RoHS to the C/S Acrovyn® range. This directive limits the use of toxic materials such as lead. Although it only applies to electrical and electronic equipment, we have found it essential to anticipate the impact on our market for the well-being of users and, more generally, for our environment. We have decided to be the forerunners.

C/S Acrovyn® : technical characteristics

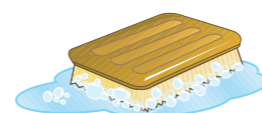

DISINFECTION AND CLEANING TEST CARRIED OUT BY LOUIS PASTEUR INSTITUTE IN STRASBOURG

The C/S Acrovyn® material is non porous so that its smooth or light textured surface makes cleaning operations easy and effective.

Tests show it:

We carried out a study of the cleaning action of disinfectant cleaners used in hospitals on C/S Acrovyn® surfaces. The report prepared by the Institute of Hygiene and Preventive Medicine of University Louis Pasteur in Strasbourg (recognised and independent body) has shown that all our products can be easily cleaned.

CHEMICAL RESISTANCE

C/S Acrovyn® resists most diluted acids, alkalis and salt solutions, mineral or vegetable oils, betadines, alcohols, White Spirit, fatty acids and others.

The complete table of chemical resistance is available upon request.



FIRE RESISTANCE : Euroclasse certification EN 13501-N (Euroclasse EN 13501-EN with test result B – s2 – dO)

C/S Acrovyn® is characterised by low flammability. It is self-extinguishing when the flame is moved away.

The reports of the tests carried out by the French LNE laboratory are available upon request.

MECHANICAL PROPERTIES

C/S Acrovyn® provides outstanding impact and scratch resistance.

The tests, carried out in standard conditions of use, showed that the tested products had suffered no damage after being hit by a load of 250 kg projected at a speed of 5 km/h.



MATERIAL RECYCLING

All products in the C/S Acrovyn® range can be recycled in the industry.

UV STABILITY

The C/S Acrovyn® resin provides perfect stability to UV indoors.





We have created several product shapes to suit the different building designs.

- A C/S ACROVYN® SHEET**
(flat surface protection for doors and walls)
Sheets cut and thermoformed as required to allow freedom of your imagination.
- B SHAPE OF NOW**
Streamlined shapes ideal for modern architecture.
- C TRADITIONAL**
Simple geometric shapes to match traditional environments.
- D HYGIENIC**
Varied shapes, with a smooth finish, specially created for locations where hygiene is a priority.
- E C/S STELATEX®**
High-resistant elastomers with simplified shapes.



C/S Acrovyn®:

A C/S Acrovyn® Colour Range

Our designers have defined a range of 30 Standard Solid colours to match floor, wall and door coverings.



B C/S Acrovyn® Faux Wood

Enjoy the warmth of wood combined with the advantages of C/S Acrovyn®. 5 woodgrains available:

- Arctic Birch
- Classic Maple
- Classic Beech
- Amber Cherry
- Cherry



C C/S Acrovyn® Faux Brushed Silver

The appeal of metal with C/S Acrovyn® properties.



D C/S Acrovyn® Faux Carbon

A revolutionary, futuristic design



Other materials :

E Vision

A translucent, coloured handrail. A C/S France unique product. 5 exciting colours.

F Metal

- Stainless steel
- Aluminium

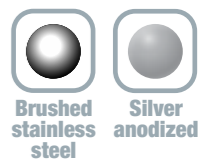

G Wood

- Beech



H C/S Acrovyn® 3000

New generation C/S Acrovyn® offering higher impact resistance, whilst protecting the environment. 8 colours.



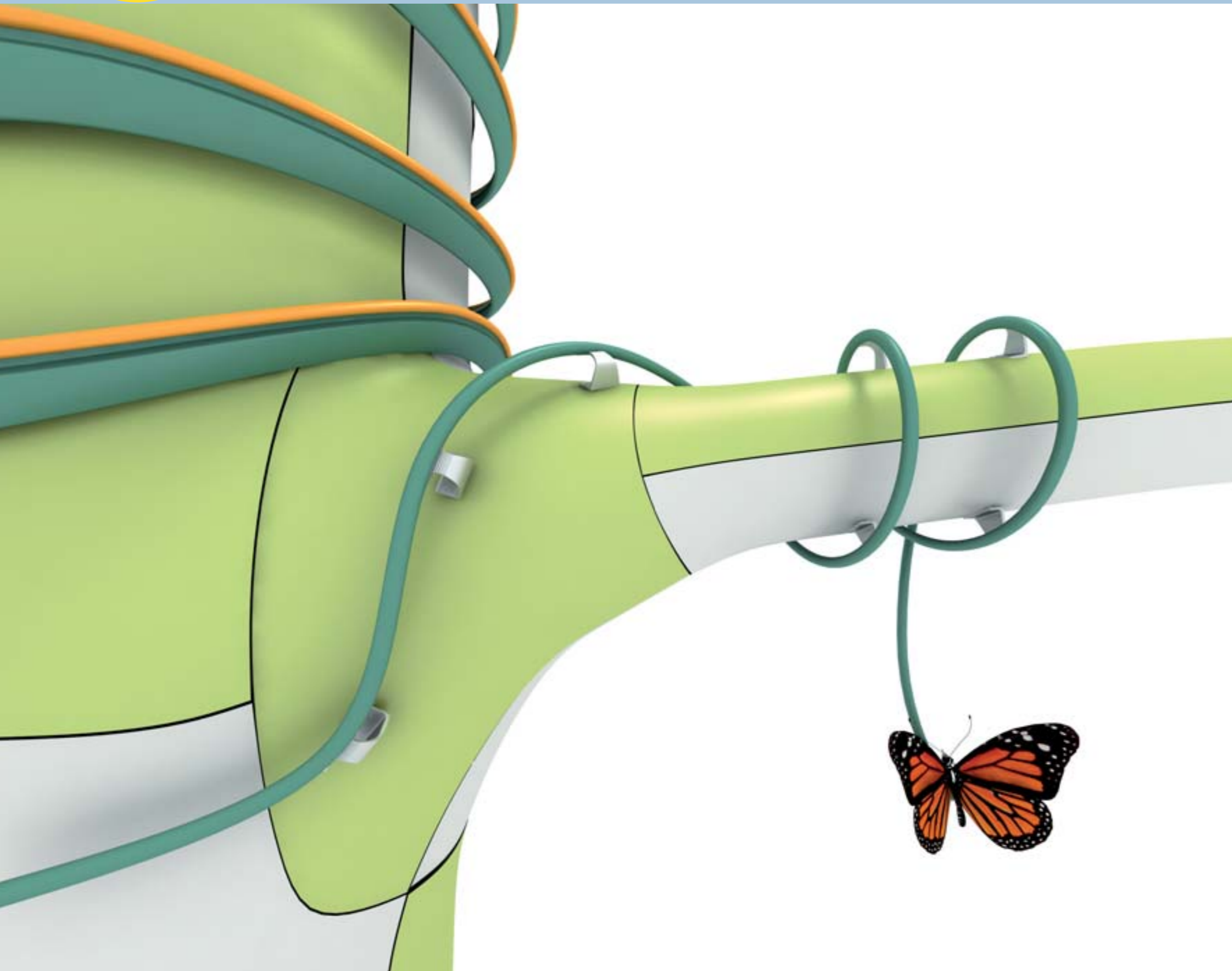

C/S Acrovyn® 3000



**C/S Acrovyn® 3000
8 colours**

Beyond the performance proven by standard Acrovyn® for over 40 years, C/S France, in its HQE approach, has developed C/S Acrovyn® 3000.

C/S Acrovyn® 3000 benefits exclusively from F2 classification, which describes the opacity and nature of the smoke released.

C/S Acrovyn® 3000 further enhances standard Acrovyn's legendary resistance to impact, whilst preserving its unrivalled design (shapes, textures, colours, etc.).



Fire
certification



Smoke
certification

ACRO SPACE™

Interior fit-out solutions

C/S Acrovyn® ideally fits into your interiors.
Our choices of colours, materials and shapes are part of an
innovative approach that aims to put design at the forefront.



Circulation areas

Circulation areas are exposed to impact and damage; with C/S Acrovyn®, they will stand the test of time.



C/S Acrovyn® sheet
Rectangular and
Half-Moon Shape

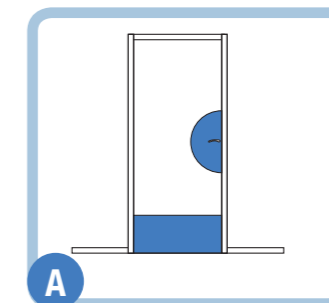

A

Tubular handrail
MCE 40/45

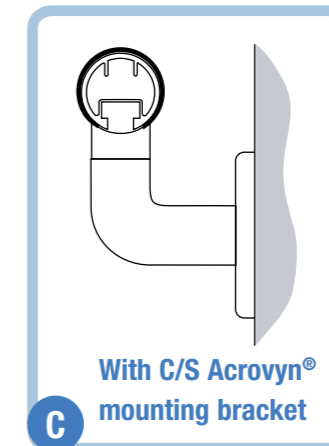

C

Stick-On Corner guard
SO 50

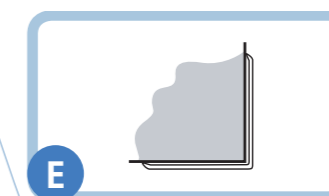

E

Tubular handrail
MCE 40/45

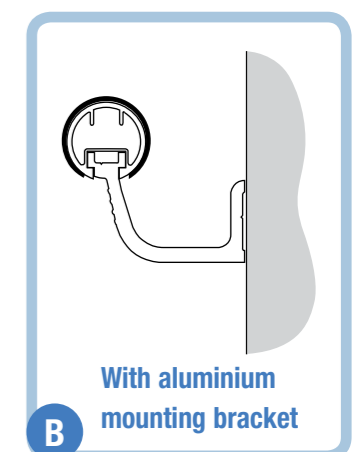

B

Trolley Plate
TP 150

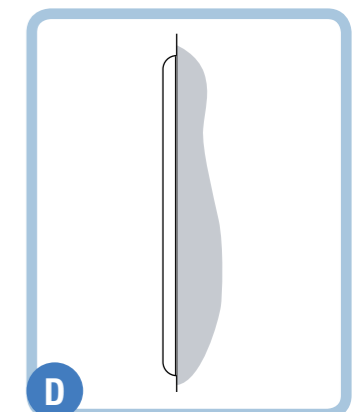

D

Variable Angle Stick-On
Corner guard
SO 50 V

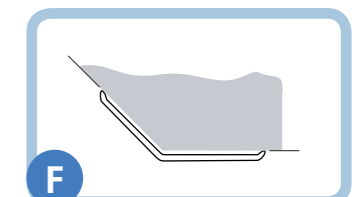

F

Corridors



Decorative wall protection enhancing your interior.

C/S Acrovyn® sheet
Half-moon Shape

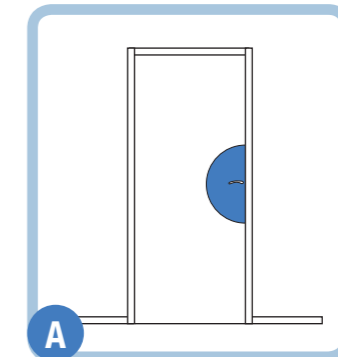

Handrail
HRB 35

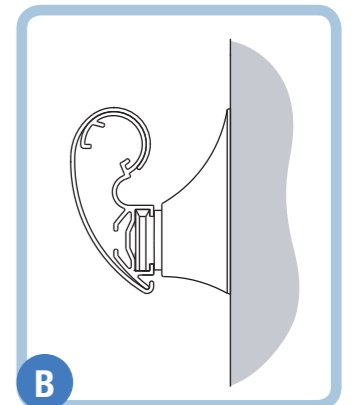

Trolley Plate
TP 300

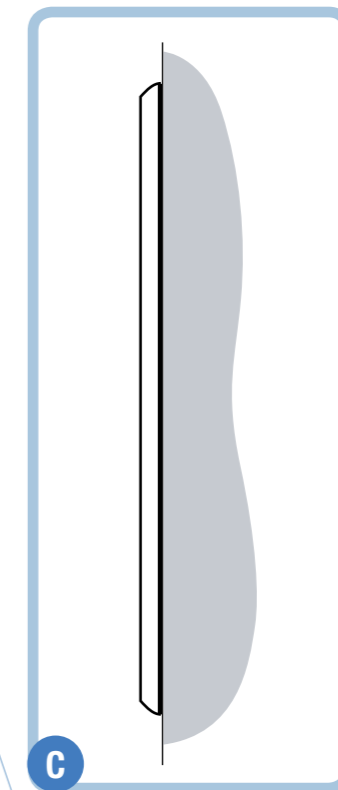

Stick On Corner guard
SO 75

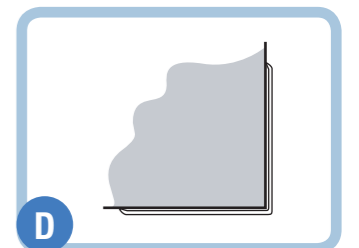

Variable Angle Stick-On
Corner guard
SO 50 V

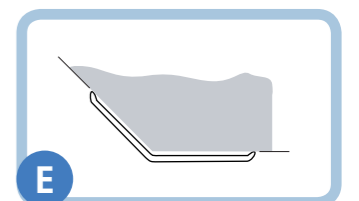

Emergencies



C/S Acrovyn® 3000
8 colours

Emergency services are subject to intense activity; C/S Acrovyn® 3000 is the ideal solution for heavy duty impact resistance.

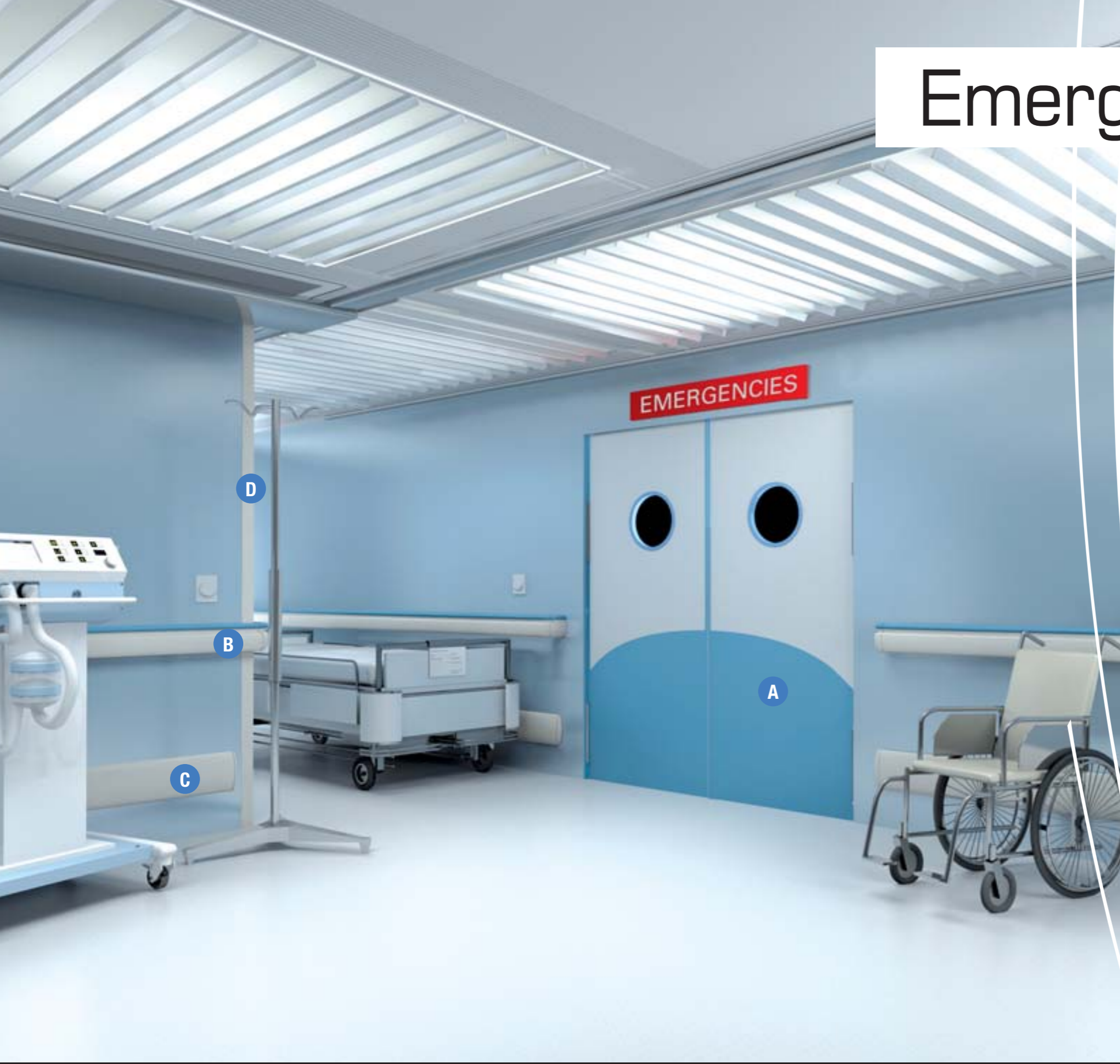

C/S Acrovyn® sheet
Dune Shape

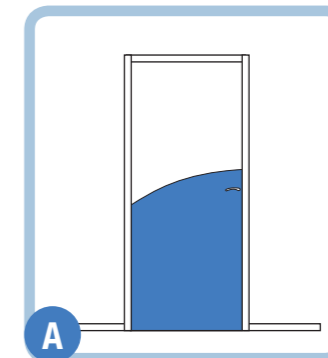

Handrail/Bumper guard
HRB 20 Duo

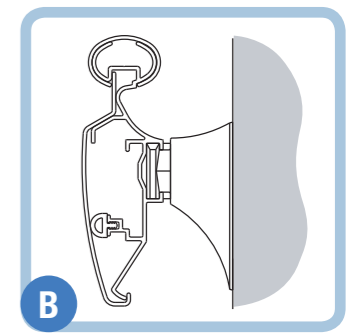

Crash rail
SCR 80M

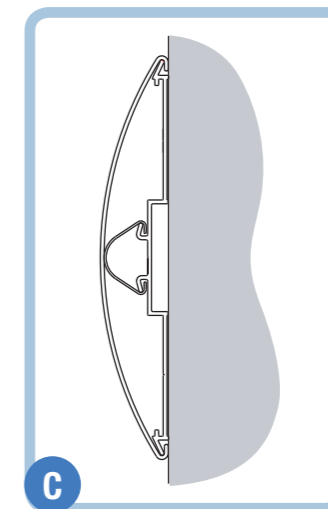

Surface Mounted
Corner guard
SSM 20

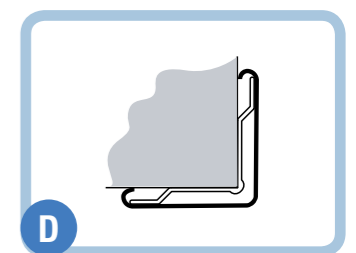

Hospital wards



DuoColour
2x5 combinations

Our products create a comfortable, bright and warm atmosphere.

C/S Acrovyn® sheet
Bed Head
protection

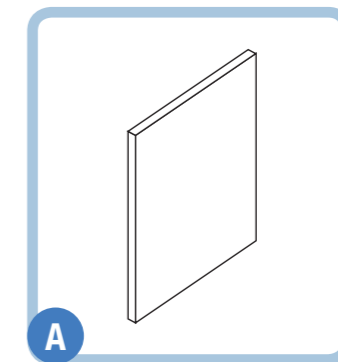

C/S Acrovyn® sheet
Valley Shape

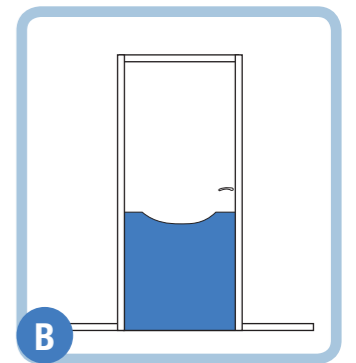

Trolley Plate
TP 200 Duo

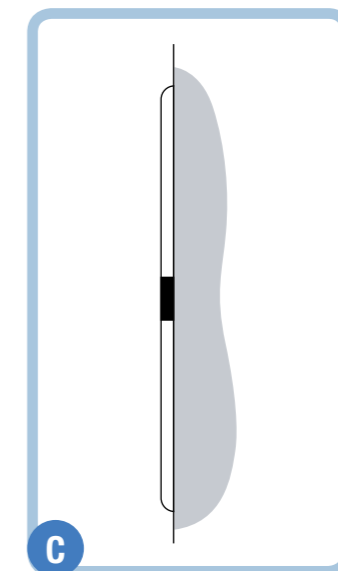

Variable Angle Stick-On
Corner guard
SO 50 V Duo

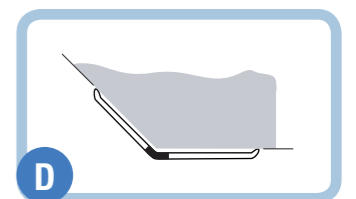

Operating theatre

Hygiene is a constant concern; you need full height wall coverings that are easy to clean. C/S Acrovyn® sheet for door and wall protection will meet your requirements.



C/S Acrovyn® smooth sheet
Wall

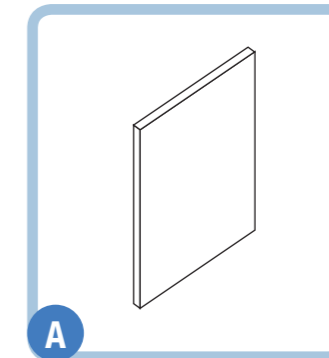

C/S Acrovyn® sheet
Thermoformed external
angle 135° with welded
joint to the adjacent
sheet

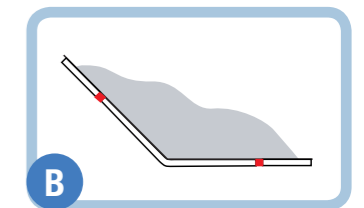

C/S Acrovyn® sheet
Thermoformed internal
angle 90° with welded
joint to the adjacent
sheet

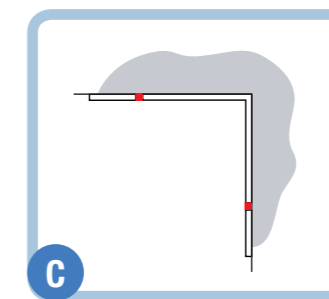

C/S Acrovyn® sheet
Welded joint

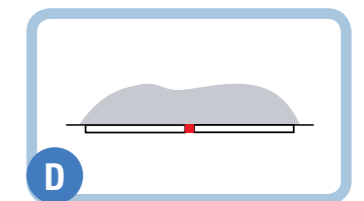

Lift / Staircase

These circulation areas are subject to heavy traffic, C/S Acrovyn® is a major benefit.



B

A

C

D

C/S Acrovyn® sheet
C/S Acrovyn® Faux
Brushed Silver

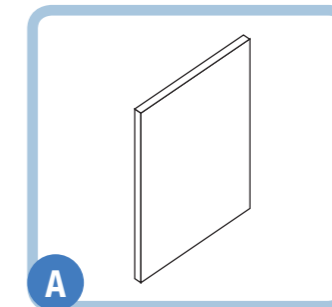

A

Handrail/Bumper guard
HRB 35 A Aluminium

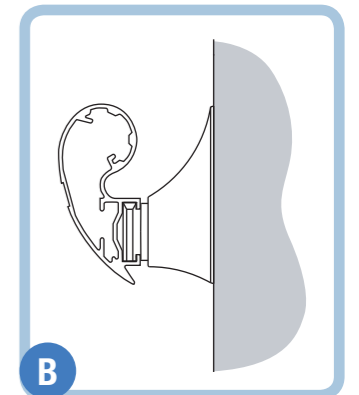

B

Tubular handrail
MCE 40/45 A Aluminium

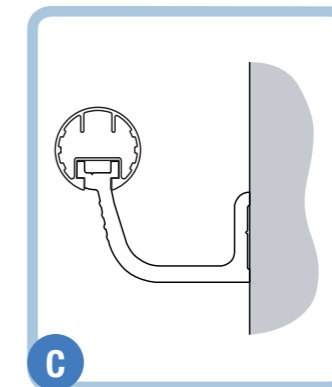

C

Surface Mounted
Corner guard
SSM 20
C/S Acrovyn® Faux
Brushed Silver

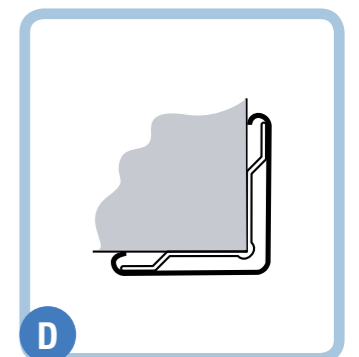

D

Cultural centre

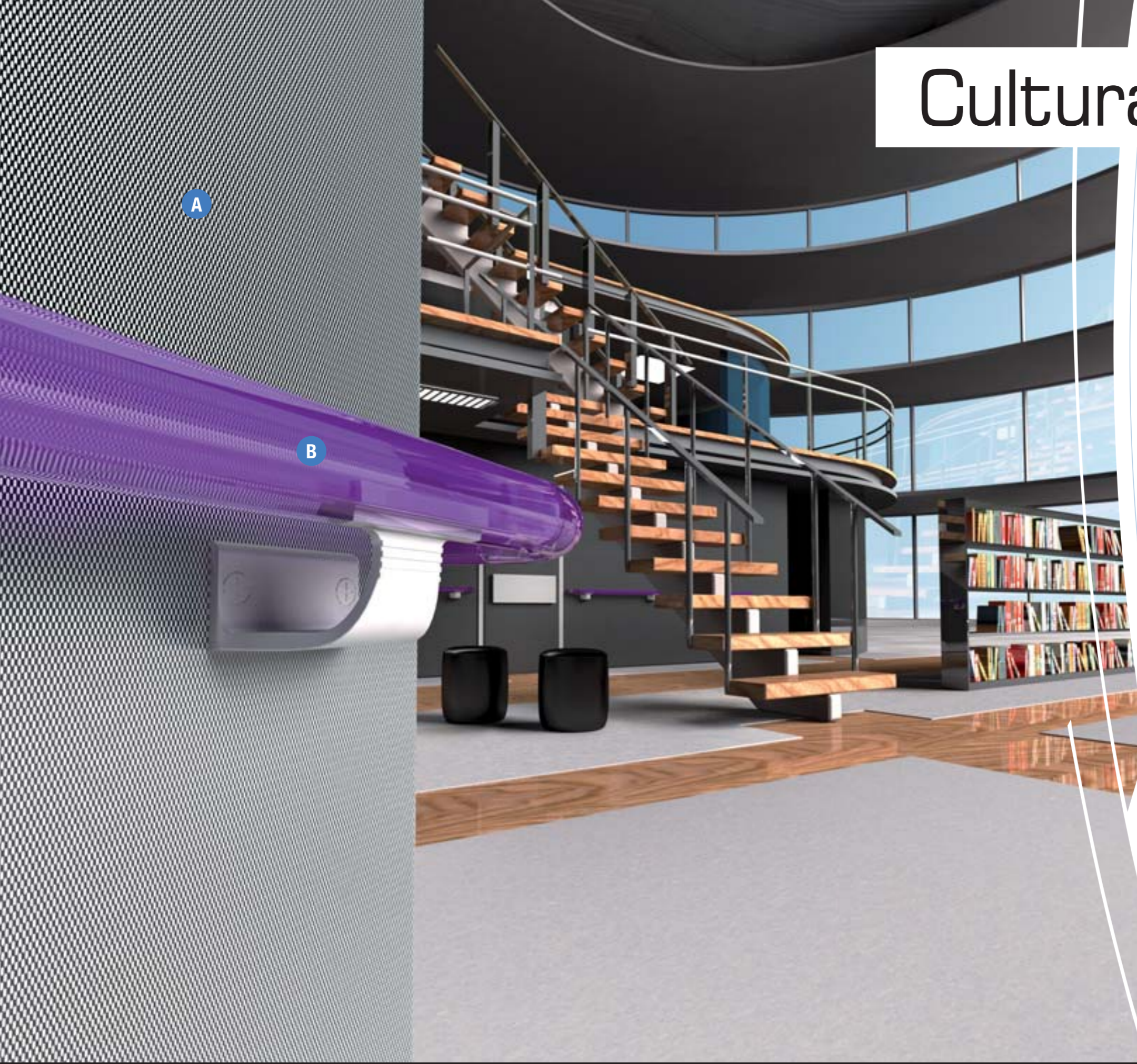

A

B

Need for stylish protection.
Our products perfectly fit into
the architecture of cultural
facilities for the pleasure
and comfort of users.

C/S Acrovyn® sheet
C/S Acrovyn® sheet
Faux Carbon

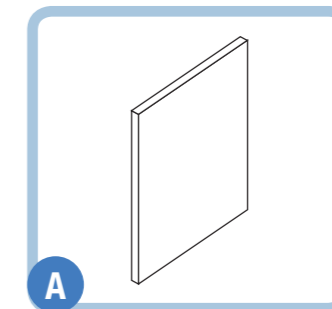

Tubular handrail
Vision

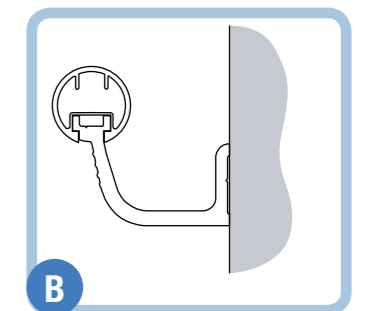

Fitness centres

The warmth of wood strengthens the feeling of well-being in your facilities.

C/S Acrovyn® sheet
C/S Acrovyn® Faux
Wood

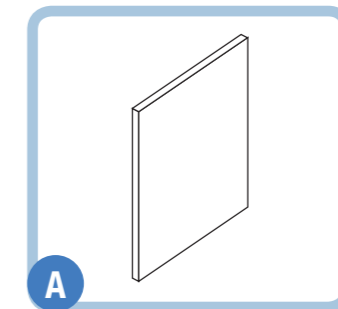

A

C/S Acrovyn® sheet
door protection
C/S Acrovyn® Faux
Wood Oasis Shape

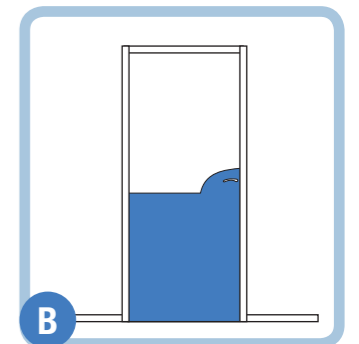

B

Tubular solid Wood handrail
MCW 40/45 Beech

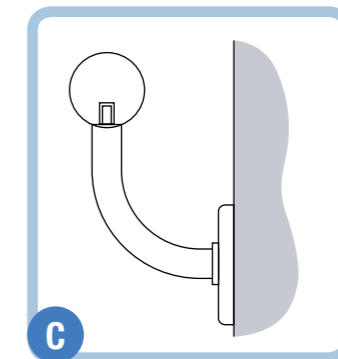

C



Education



C/S Acrovyn® products help to create an inviting, child-friendly environment which stimulates learning.

C/S Acrovyn® sheet
Textured

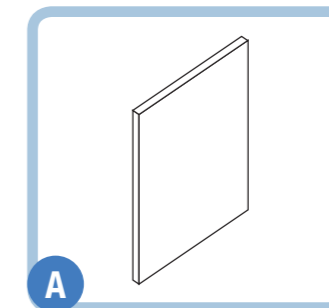

C/S Acrovyn® sheet
Fresque

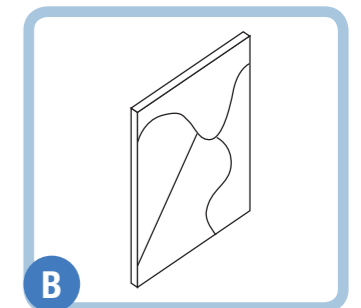

Tubular handrail
Vision

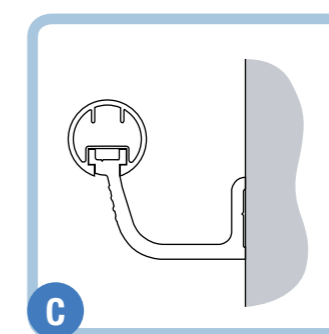

Stick-On Corner guard
SO 30

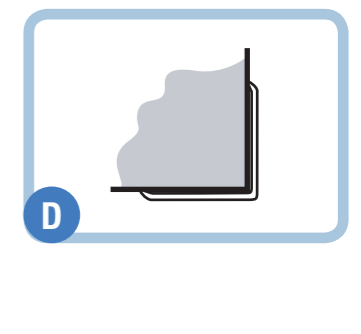

Catering

Resistant and easy to clean, our products meet the high impact resistance and hygienic requirements in catering facilities.



C/S Acrovyn® sheet
Smooth

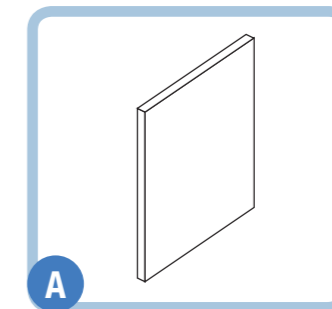

Stainless steel crash rail
CRS 200

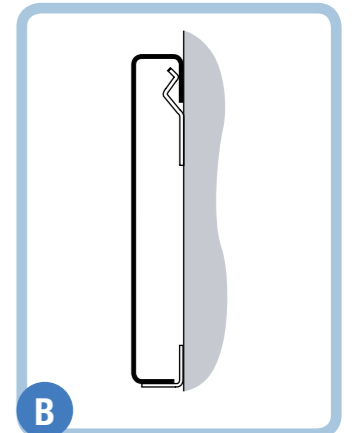

Smooth Crash rail
Aronde 170 Duo

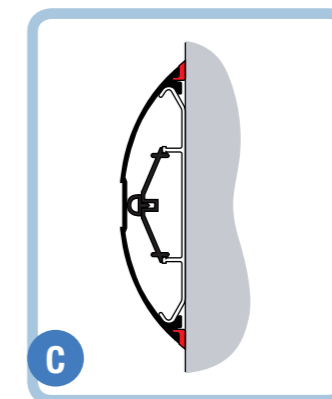

Stainless steel
Corner guard
50A

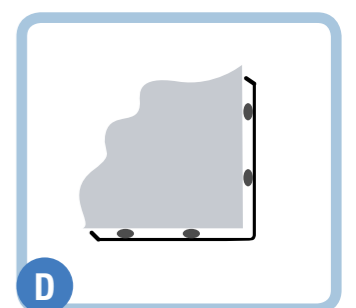

Restaurant



**C/S Acrovyn®
Faux Wood**

For a convivial, welcoming and warm dining room, C/S Acrovyn® Faux Wood is the ideal solution, which provides design options and durability. Our C/S Acrovyn® interior wall protection creates your personal design and ensures long term protection.

**C/S Acrovyn® sheet
C/S Acrovyn® Faux
Wood**

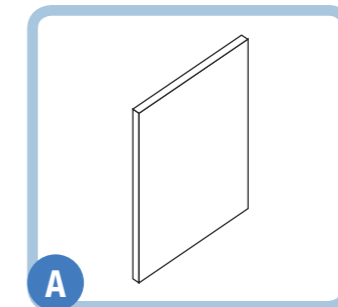

A

**Tubular handrail
HR 06**

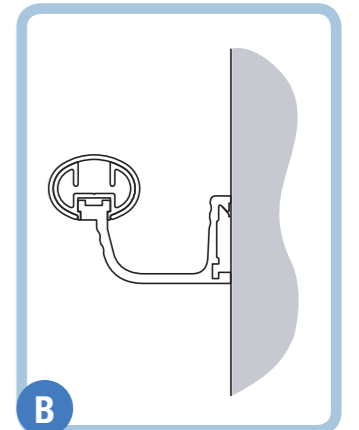

B

**Crash rail
SCR 80M**

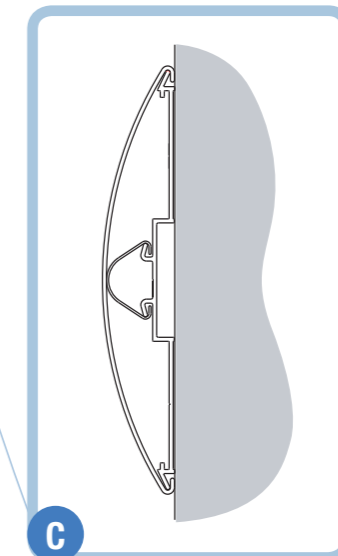

C

**Surface Mounted
Corner guard
SSM 20**

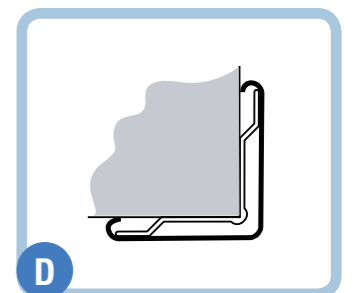

D

Industrial laboratory

C/S Acrovyn® meets all requirements such as safety and hygiene in a simple and pleasant style.



C/S Acrovyn® sheet
Smooth

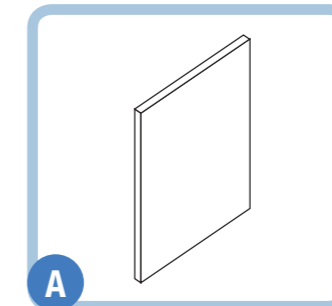

Full aluminium
Bumper handrail
ECR 32 A

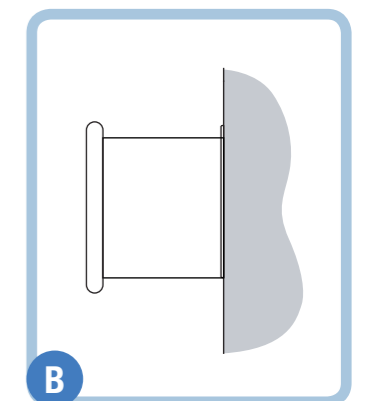

Smooth Crash rail
Aronde 170

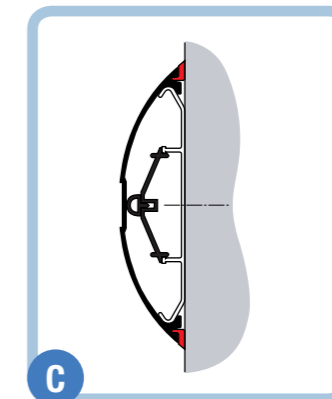

Surface Mounted
Corner guard
SSM 20
C/S Acrovyn® Faux Brushed
Silver

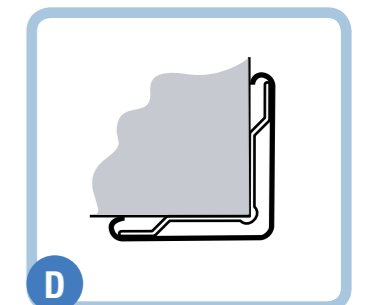

SERVICE

Retail outlets

Streamlined and efficient, our protection products harmoniously fit into all your sales areas.



Handrail/Bumper guard
ECR 32 A

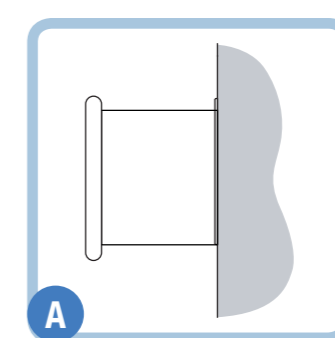

Low Level Rail
Stainless steel
LLR-SS

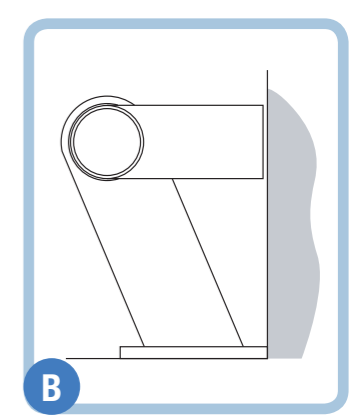

Feature Rail
FR 225

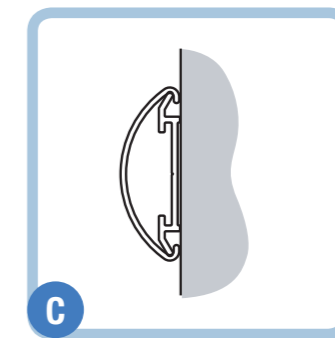

Surface Mounted
Corner guard
SM 20

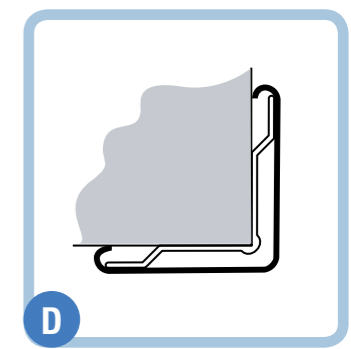

Hotel

We propose to customize your style for the pleasure and satisfaction of your customers.

C/S Acrovyn® sheet
C/S Acrovyn® Faux
Wood

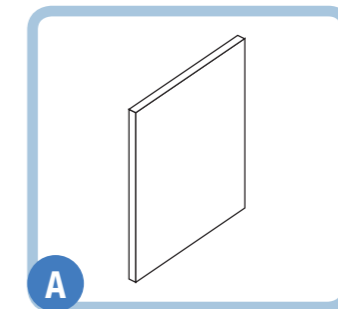

C/S Acrovyn® sheet
Customized door
protection

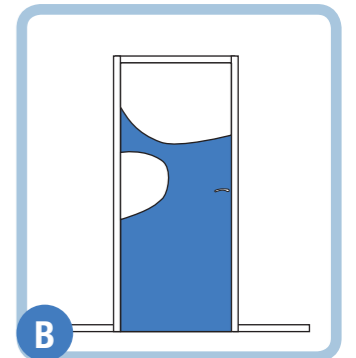

Feature rail
FR 225

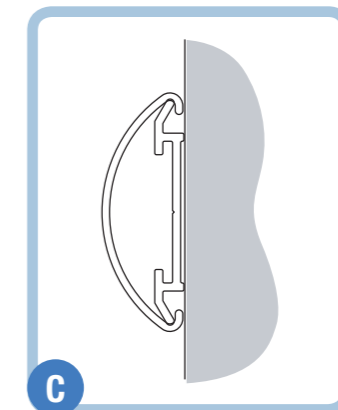

Surface Mounted
Corner guard
SSM 20
C/S Acrovyn® Faux Wood

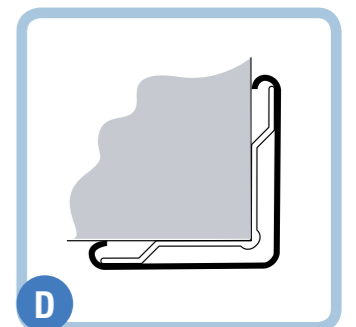

Logistical centres

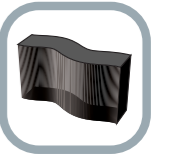

Elastomer

Heavy Duty protection,
C/S Stelatex® is the range that
suits all areas handling heavy loads.

C/S Stelatex® Fender
100 D

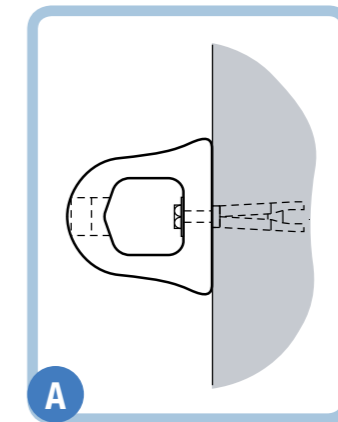

C/S Stelatex® Rubber
Bumper guard
200 W 50

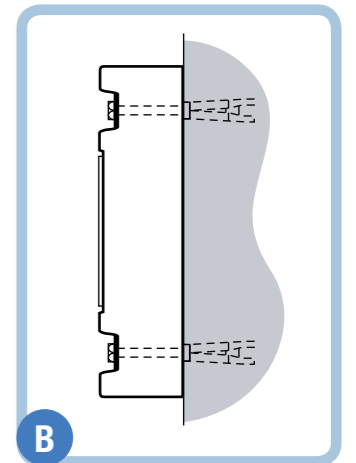

C/S Stelatex® Rubber
Corner guard
100 C

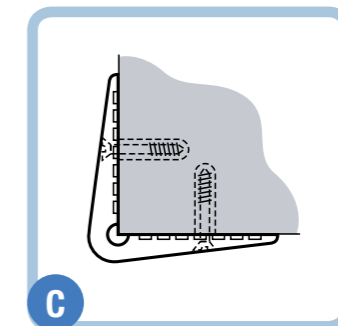

Transport interchanges



C/S Acrovyn® 3000
8 colours

Our products, both functional and aesthetic, fit into the architectural design, underline it and make it durable.

C/S Acrovyn® sheet
C/S Acrovyn® 3000

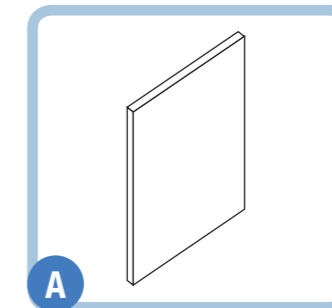

Low Level Rail
Stainless steel
LLR-SS

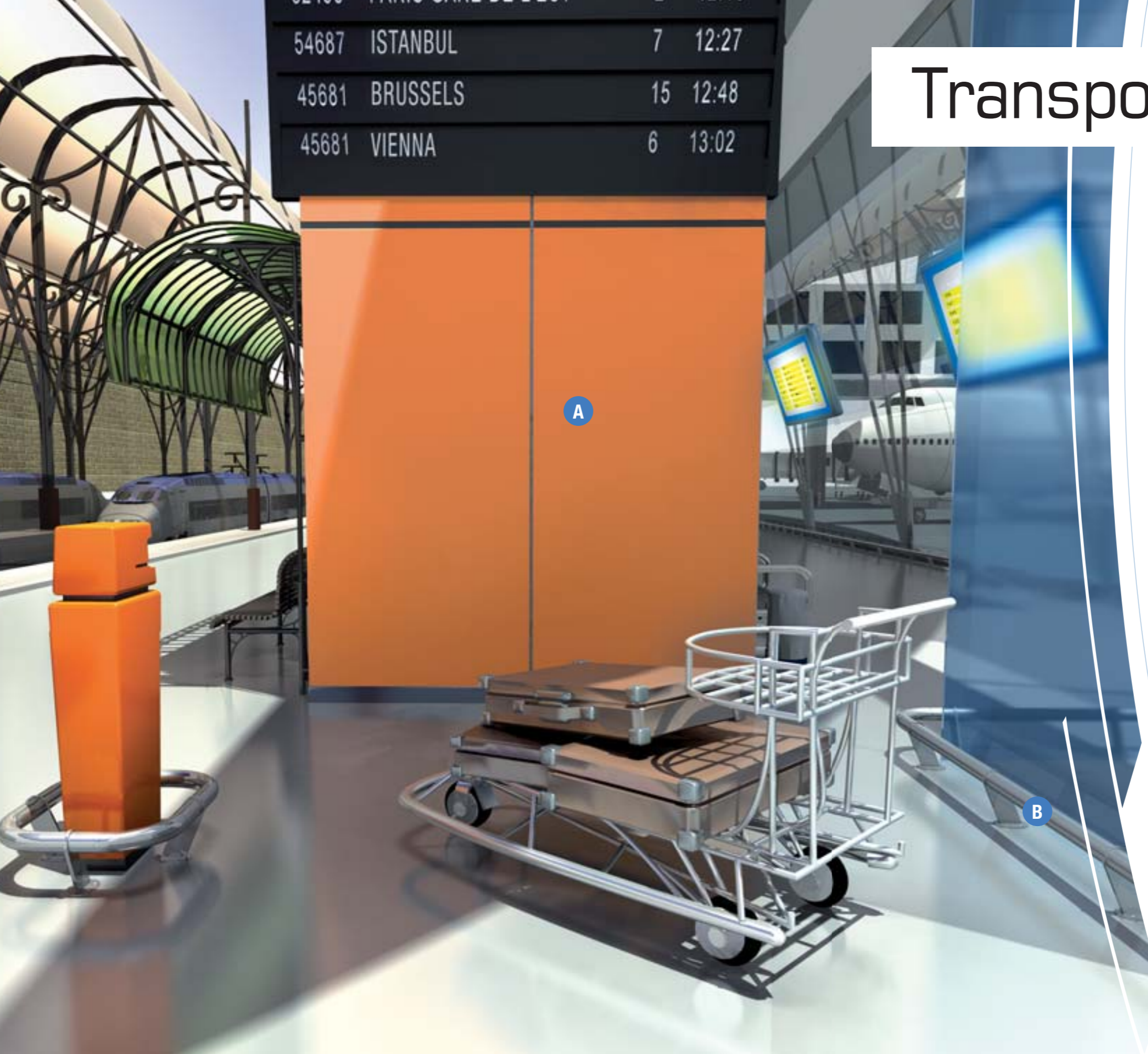
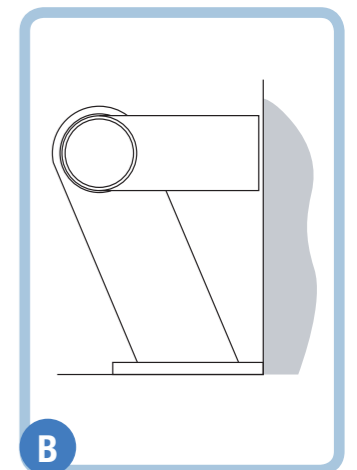





ACRO ITEMS™

Everything you should know about our products

Detailed list of our products
and all their characteristics



PERFORMANCE OF C/S ACROVYN® SHEETS

- Fire resistant
 - Self-extinguishing
 - acc. to Euroclasse EN 13501-EN with test result B – s2 – d0



- Impact resistance
 - Outstanding resistance: capable of resisting a load of 250 kg projected at a speed of 5 kmh!



- Hygiene: non porous structure
 - Prevents the development of bacteria
 - Fast and easy to clean



Disinfection and cleaning certification delivered by the Institute of Hygiene and Preventive Medicine of University Louis Pasteur.

TEXTURES AND COLOURS

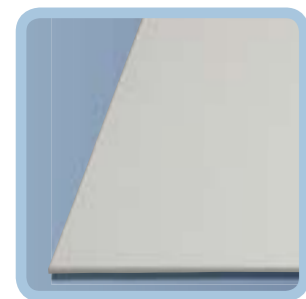

Textured



Smooth

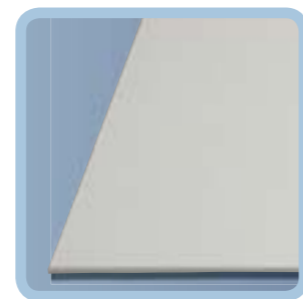

Textured

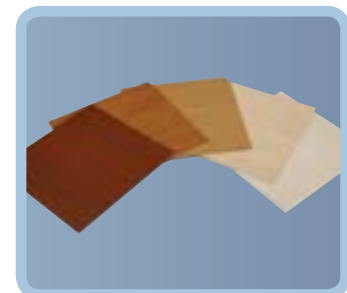

Smooth - 5 Woodgrains

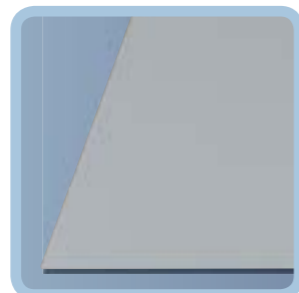

Smooth

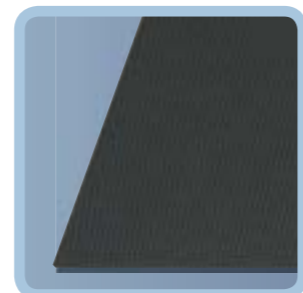

Smooth

FULL SIZED SHEETS

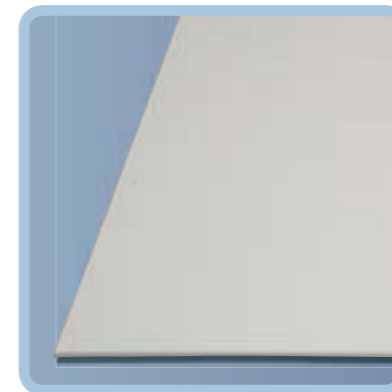

C/S Acrovyn® sheet
2 mm Textured

3000 X 1300 mm



C/S Acrovyn® sheet
2 mm Smooth

3000 X 1300 mm

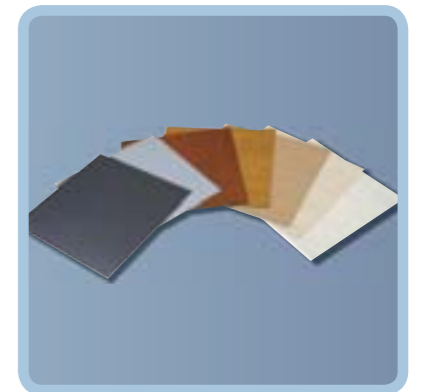

C/S Acrovyn® sheet
2 mm Smooth

3000 X 1250 mm

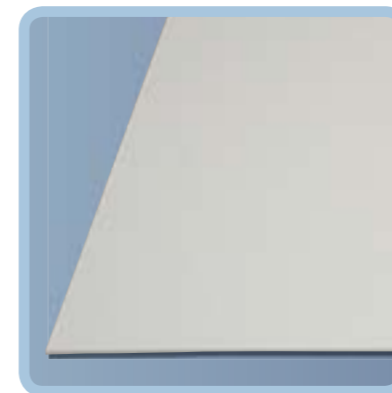

C/S Acrovyn® sheet
1.5 mm Textured

3000 X 1300 mm

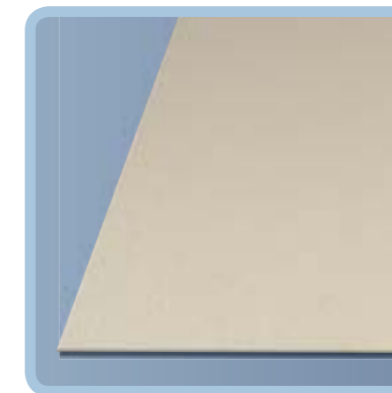
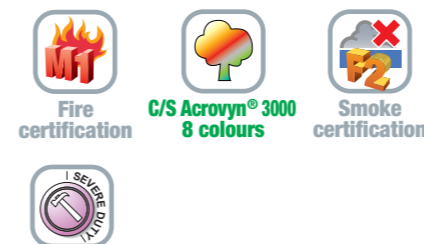

C/S Acrovyn® sheet
0.8 mm Textured

3000 X 1300 mm



CUT TO SIZE SHEETS

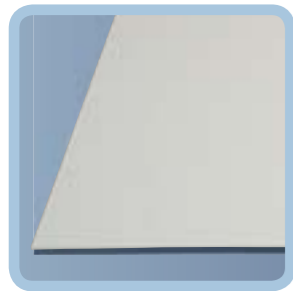

**C/S Acrovyn® sheet
2 mm Textured**



**C/S Acrovyn® sheet
2 mm Smooth**

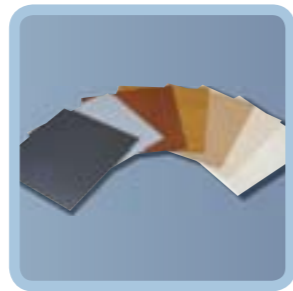

**C/S Acrovyn® sheet
2 mm Smooth**

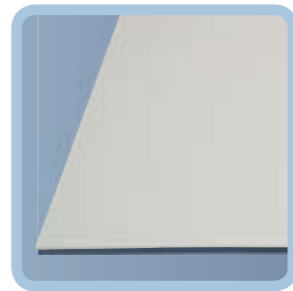

**C/S Acrovyn® sheet
1.5 mm Textured**

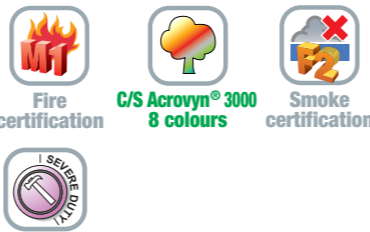

Examples of standard wall and door applications:

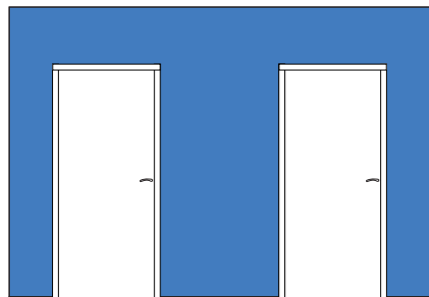

Full height

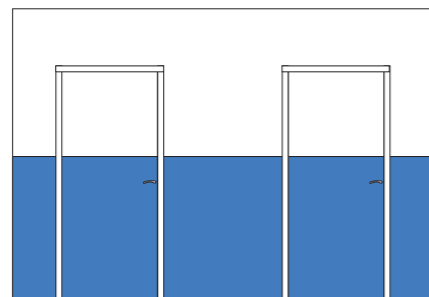

Mid-wall height 1300 mm

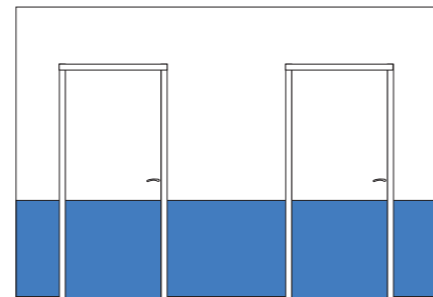

Mid-wall height 900 mm

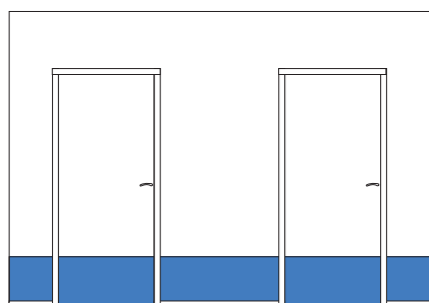

Height 430 mm

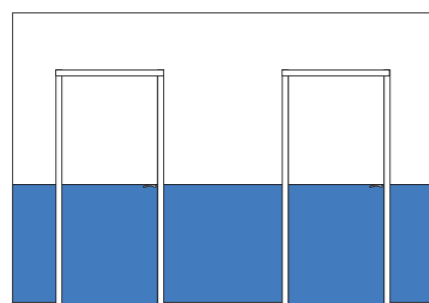

Customs height

Standard decorative wall protection shapes :

ALIZÉ wave

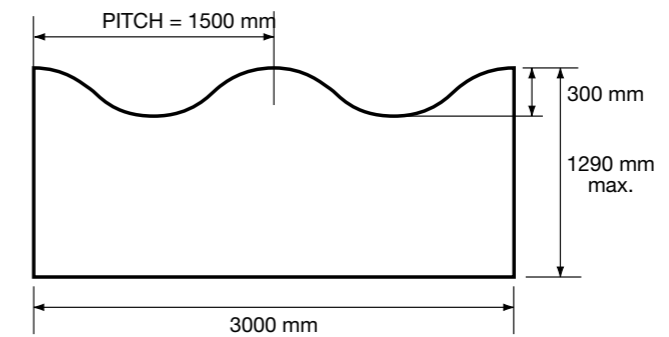

SIROCCO wave

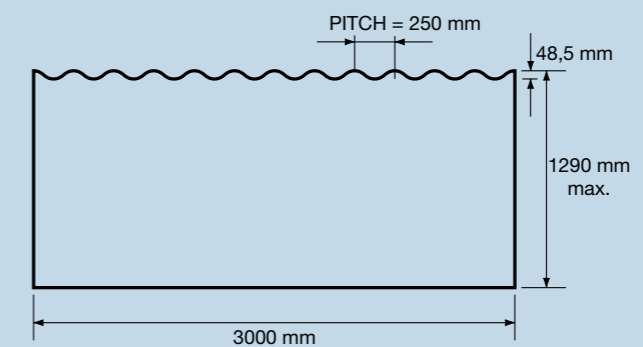

MISTRAL wave

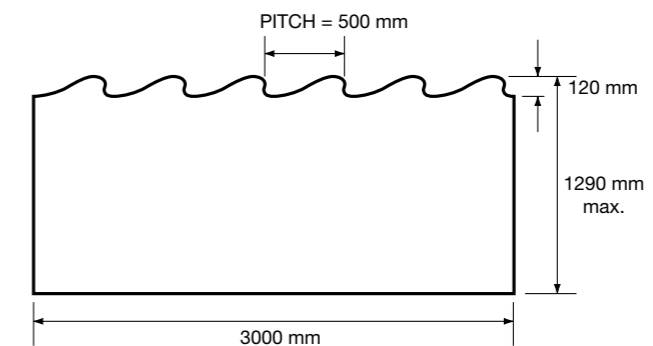

TRAMONTANE wave

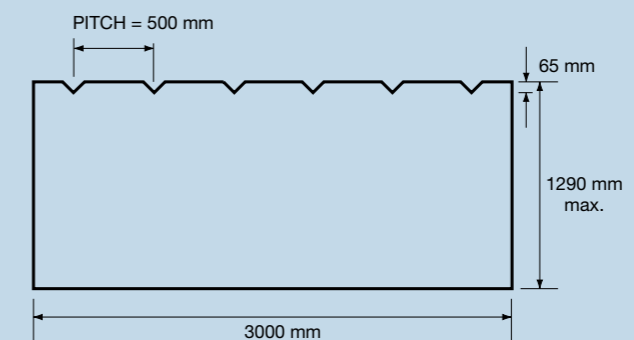

Standard decorative door protection shapes

C/S Acrovyn® decorative partial height cladding :

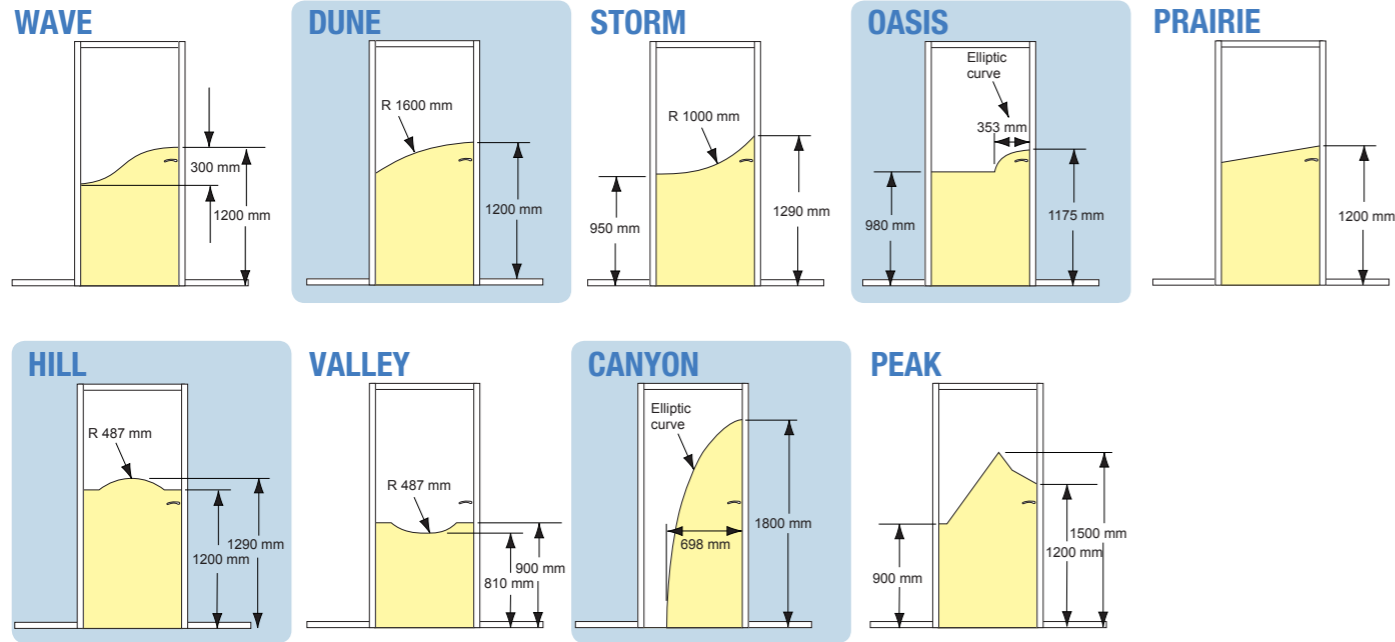

Kick plate and push plate :

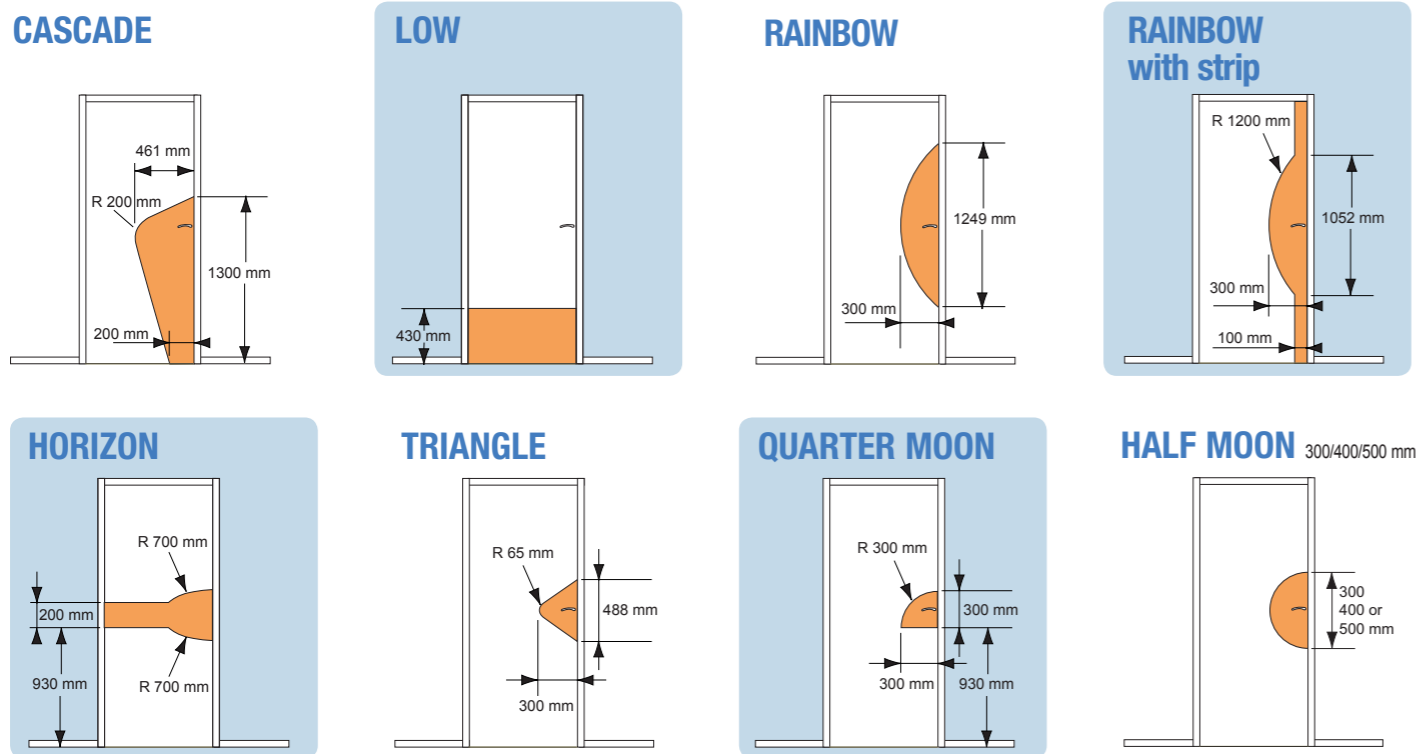

FREE CREATIVE PATTERNS

Create your own designs

All designs featured in the ACRO SPACE™ section can be produced using our advanced cutting technology.

Please supply your designs in dxf format and we will fabricate them for you. If you need any help with creating your designs call our Customer Service Team.

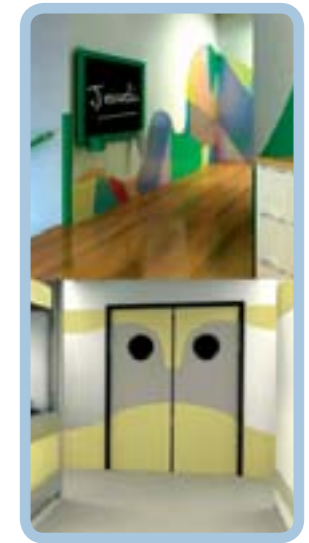
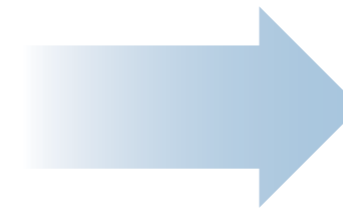

CUSTOMIZED SIGNPOSTING



FORMING

Thermoforming

Thermoforming L



Edge bevelling 45° on 2-mm sheet

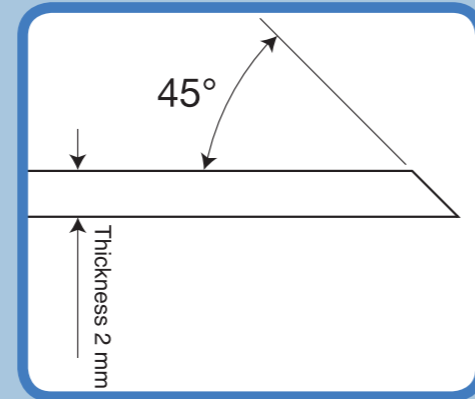

Thermoforming

Postforming

L-shaped angle thermoforming "1 fold from 45 to 179°"



U-shaped channel thermoforming "2 folds"



Custom-made thermoforming

WALL APPLICATIONS



For locations subject to strict hygienic regulations, a 2 mm gap between sheets forming an expansion joint shall be filled with supple materials such as silicone mastic or welding rod.



Precoloured silicone



Welding rod

Specific points for perfect hygiene:

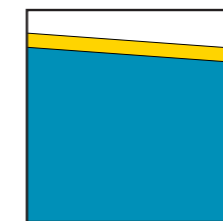

Silicone mastic seal

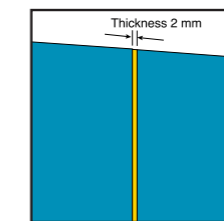

Welding between sheets

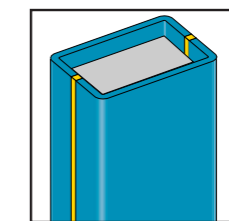

Pillar protection

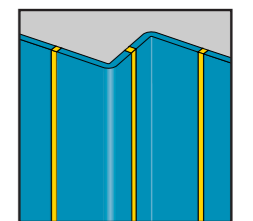

Junction between external and internal angle

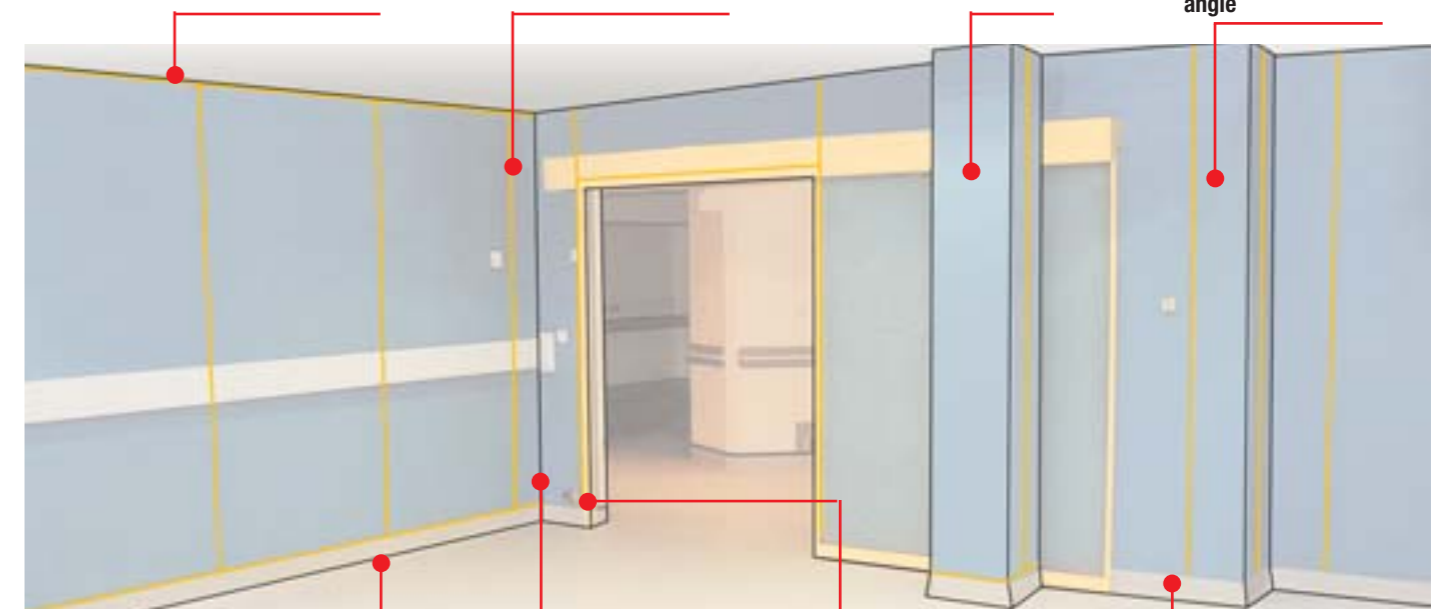

C/S Acrovyn® plinth H = 100 mm



Radiused internal angle thermoformed

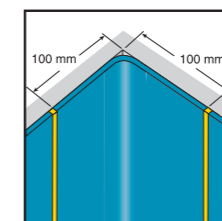

Door frame protection

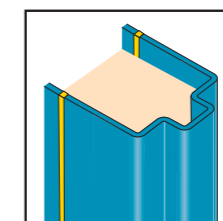

Heat-sealed junction with flexible flooring

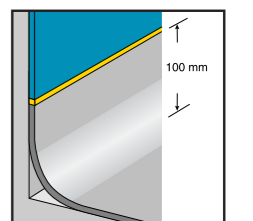

DOOR APPLICATIONS

SIMPLE PROTECTION

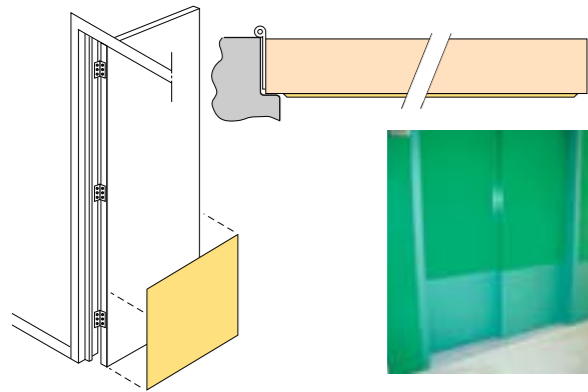

This is the **SIMPLEST** and **EASIEST** application case.

ADD-ON U-PIECE AND SHEETS

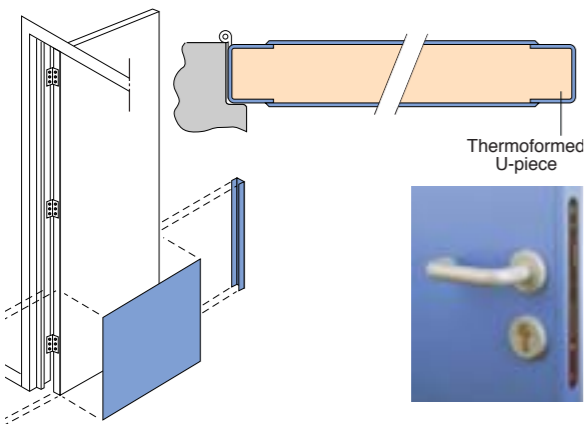

This is the model suitable for the most abused surfaces.

The door edges are protected by a U- thermoformed profile. Both door faces are covered with cut-to-size sheets with bevelled edges.

Note: Door edges should be rebated by the corresponding thickness of the C/S Acrovyn® sheet (2 mm thickness).

PROTECTION OF DOOR FRAMES

Door rebates and frames can also be protected by one-piece, postformed or thermoformed C/S Acrovyn® sheets cut to the exact dimensions of wood or metal frames.

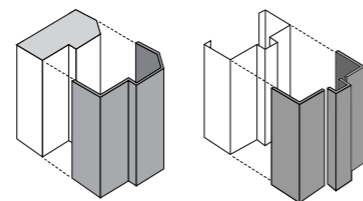

2 L-THERMOFORMED PARTS

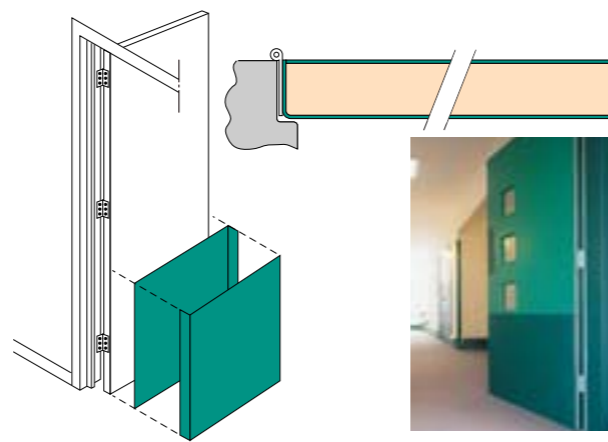

The protection is made in 2 L-angled thermoformed parts. **The door edges are perfectly protected.**

SPECIAL FOR MOIST LOCATIONS (in this case, use glue M500)

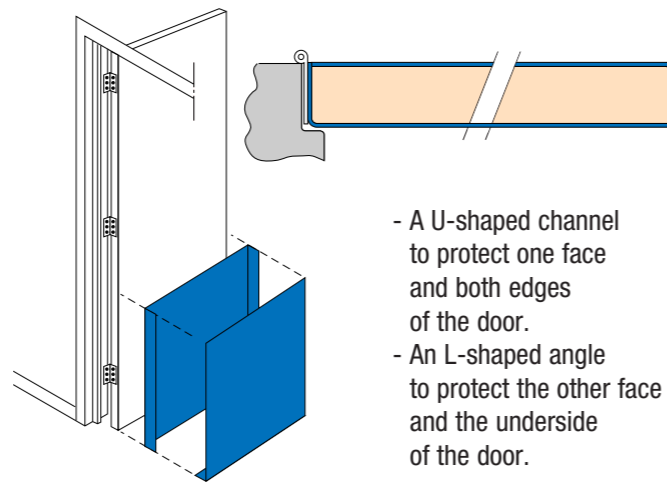

- A U-shaped channel to protect one face and both edges of the door.
- An L-shaped angle to protect the other face and the underside of the door.

INSTALLATION ACCESSORIES:



UZIN PE 360 Primer
To be applied to absorbent surfaces (coverage usage : 0.15 kg/m²)



UZIN KE 2000 S water based glue Single-sided adhesive (coverage usage : 0.35 kg/m²). Odourless, for absorbent surfaces

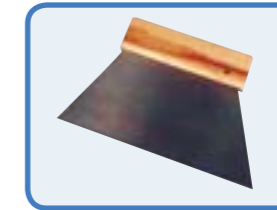

Spreader tooth A2
1 for 100 m²



EMFI 695 glue cleaner
Cleaning of tools and primer application (0.08 l/m² thinner + 0.08 l of adhesive)



EMFI Gelcoat glue
Double-sided adhesive (coverage : 0.33 l/m²)



OTTOCOLL TopFix
cartridge 300 ml for absorbent surfaces

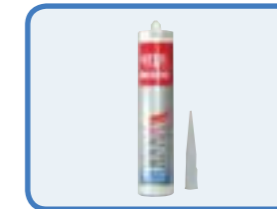

OTTOCOLL M500
cartridge 300 ml, specially for moist locations, for non-absorbent surfaces

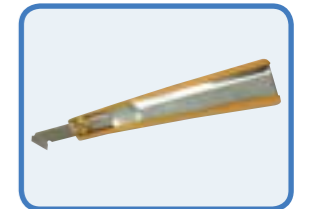

Craft knife
for C/S Acrovyn® sheets



Crane roller
With two articulated grips



Paint remover AGS 560
Spray



Welding equipment
Complete kit

FINISHING ACCESSORIES:



C/S Acrovyn® plinth CB 100
• Standard length: 3.70 m
• Height: 100 mm with flexible lip
• **6 colours available:**
Eggshell 100 / French Cream 101
Pearl Grey 136 / Charcoal Grey 162
Mocha 105 / Wedgewood Blue 111.

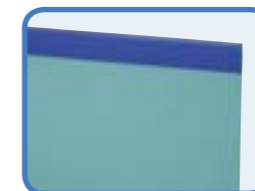

Upper finishing trim
• 30 Standard colours
• Standard length: 3 m



Vertical trim
• 30 Standard colours
• Standard length: 3 m



Welding rod
• For sheet thickness 1.5 to 2 mm
• Roll 100 m
• 30 Standard Solid C/S Acrovyn® colours,
• **C/S Acrovyn® 3000**,
2 colours available:
Snow White 9003
Dove Grey 24



Precoloured silicone
• Cartridge: 300 ml
• 30 Standard colours

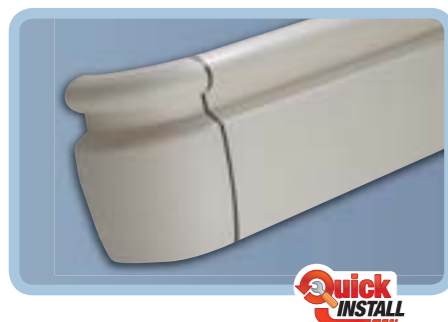

HRB 20

Profile length: 4 m.

Mounting accessories:

- Mounting bracket
- Standard end cap and external corners, 135° corners
- Splice plate
- Removable kit for service duct
- Quick Install spanners



See photo page 24

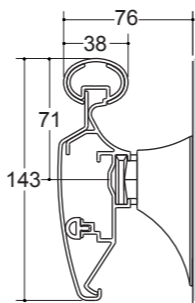

HRB 35

Profile length: 4 m.

Mounting accessories:

- Mounting bracket
- Standard end cap and external corners, 135° corners
- Splice plate
- Removable kit for service duct
- Quick Install spanners

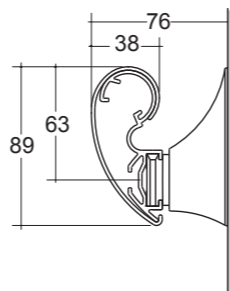
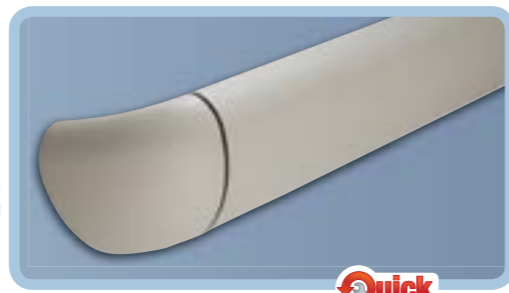

See photo page 22

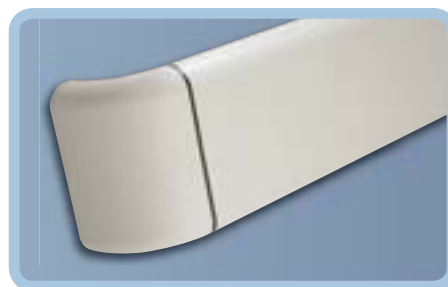

HRB 4C

Profile length: 4 m.

Mounting accessories:

- Mounting bracket
- Standard end cap and external corners, 135° corners
- Splice plate

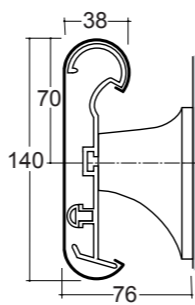

See photo page 30

ECR 32 A

Prefabricated ready-to-install kit.

Mounting accessories:

- Mounting bracket
- Standard end

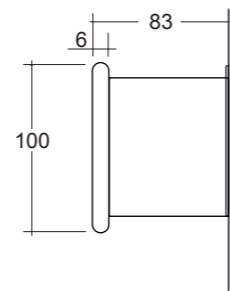

See photo pages 44 and 46

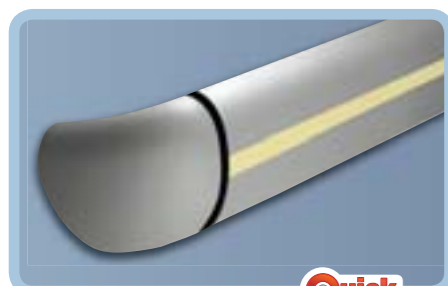

HRB 35 A

Profile length: 4 m.

Mounting accessories:

- Mounting bracket
- Standard end cap and external corners, 135° corners
- Splice plate
- Removable kit for service duct
- Quick Install spanners
- Decorative contrasts strip 30 colours

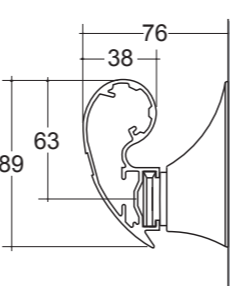

See photo page 32

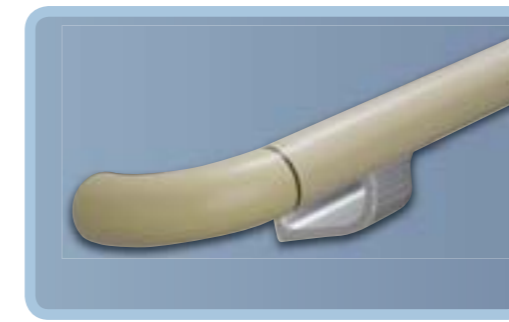

MCE 40/45

Profile length: 4 m.

Mounting accessories:

- Aluminium or C/S Acrovyn® mounting brackets
- Standard end cap and external corners, 135° corners
- Splice plate
- Removable kit for service duct

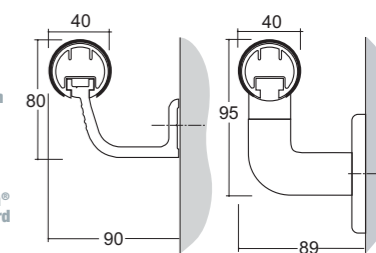

See photo pages 20

MCE 40/45 A Aluminium

Profile length: 4 m.

Mounting accessories:

- Aluminium mounting bracket
- Standard end cap and external corners, 135° corners
- Splice plate
- Removable kit for service duct

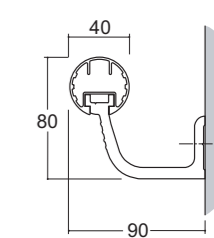
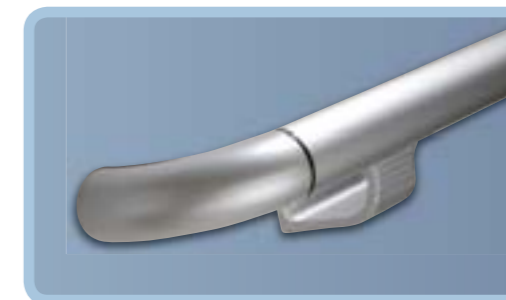

See photo pages 32



VISION

Profile length: 4 m.

Available in a choice of 5 translucent colours

Mounting accessories:

- Polished aluminium mounting bracket
- Standard end cap and external corners, 135° corners
- Splice plate
- Removable kit for service duct

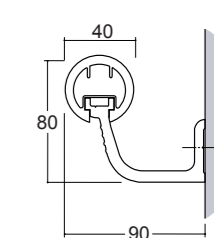

See photo pages 34 and 38

HR 06

Profile length: 4 m.

Mounting accessories:

- Aluminium or C/S Acrovyn® mounting brackets
- Standard end cap and external corners, 135° corners
- Splice plate
- Removable kit for service duct

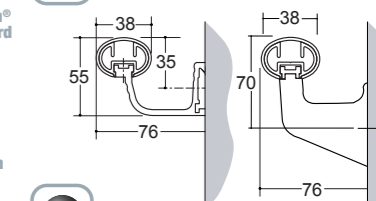

See photo page 42



MCW 40/45

Profile length: 2 m

Prefabricated ready-to-install kit.

Mounting accessories:

- Stainless steel or C/S Acrovyn® mounting bracket
- Standard end cap and external corners, 135° corners
- Splice plate
- Removable kit for service duct

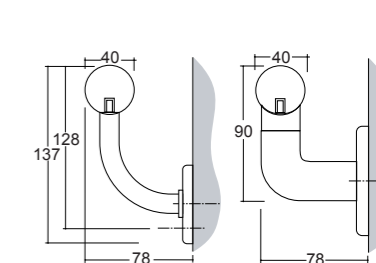

See photo page 36

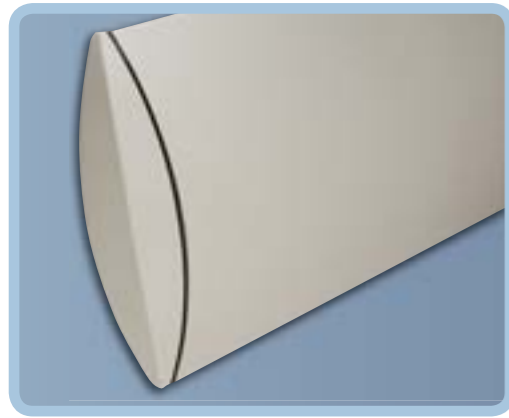

SCR 80M

Profile length: 4 m.
Available in 2 versions:

- SCR 80M with continuous aluminium retainer
- SCR 80, Economic version with aluminium mounting brackets at 600 mm centres

Mounting accessories:

- Standard end cap, external corner
- Splice plate

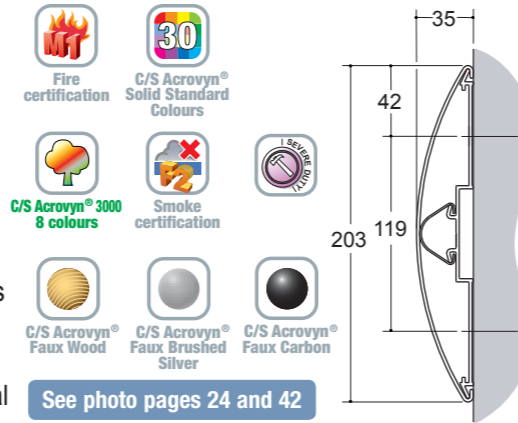

See photo pages 24 and 42

SCR 50M

Profile length: 4 m.
Available in 2 versions:

- SCR 50M with continuous aluminium retainer
- SCR 50, Economic version with aluminium mounting brackets at 600 mm centres

Mounting accessories:

- Standard end cap, external corner
- Splice plate

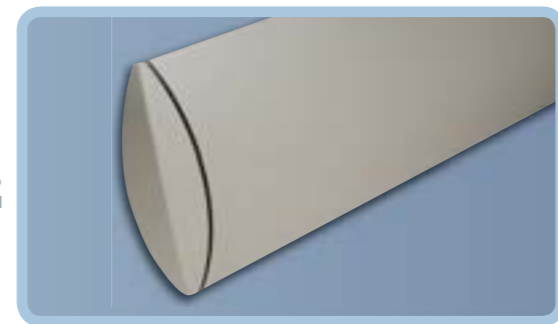

See photo page 30

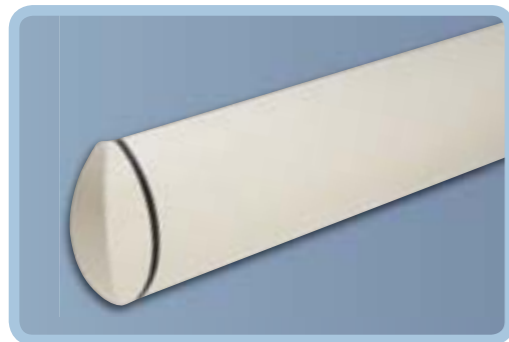
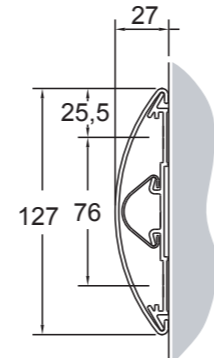

FR 225

Profile length: 4 m.
with continuous aluminium retainer

Mounting accessories:

- Standard end cap, external corner

See photo pages 30, 46 and 48

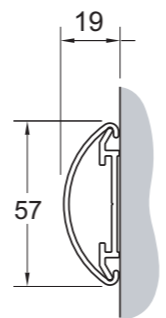

ARONDE 170

Profile length: 4 m.
Available in 2 versions:

- ARONDE 170, with continuous vinyl bumper rail and aluminium mounting brackets at 600 mm centres
- ARONDE 170 E, Economic version, mounted with aluminium mounting brackets only at 600 mm centres

Mounting accessories:

- Standard end cap, external corner
- Splice plate
- Decorative contrast strip in 30 colours

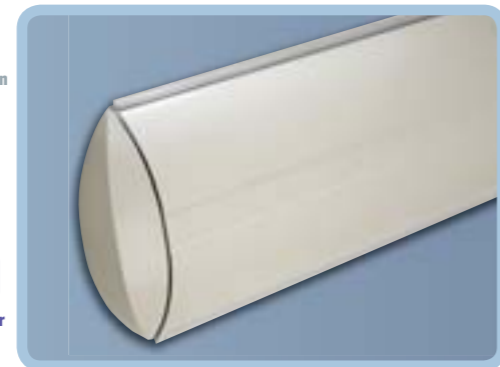
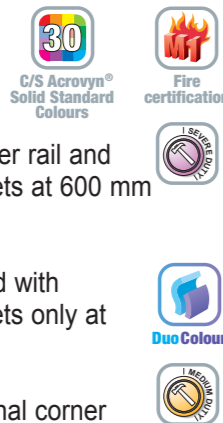

See photo pages 40 and 44

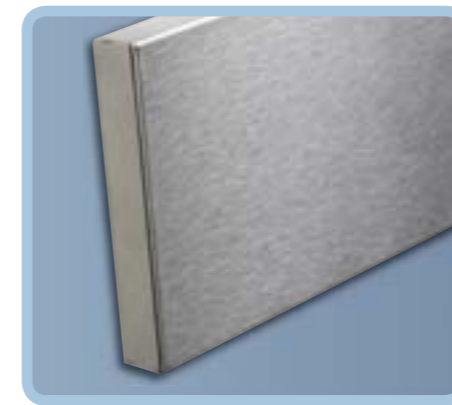
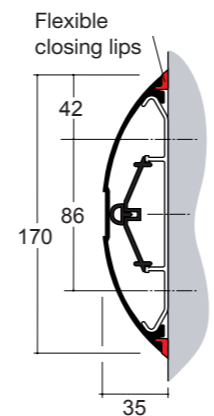

CRS 200

Prefabricated ready-to-install kit, 3 m max., with upper and lower, pre-drilled mounting strips.

Cover : thickness 1.2 mm
Food-approved, brushed stainless steel (304 L).
Closed prefabricated welded end caps.

See photo page 40

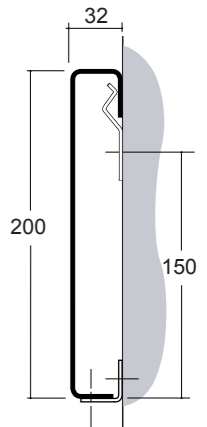

CRS 150

Prefabricated ready-to-install kit, 3 m max., with upper and lower, pre-drilled mounting strips.

Cover : thickness 1.2 mm
Food-approved, brushed stainless steel (304 L).
Closed prefabricated welded end caps.

See photo page 40

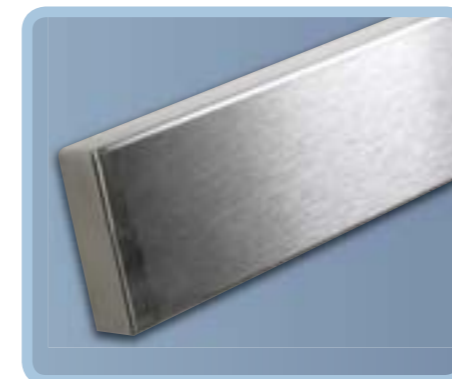
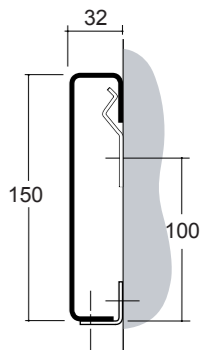
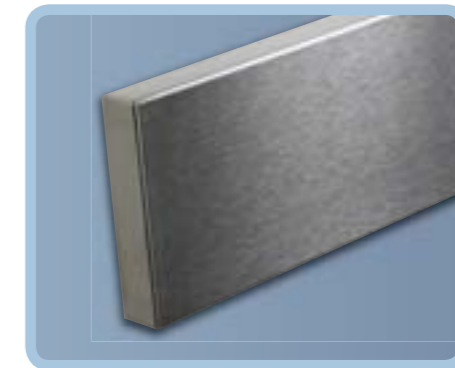

CRS 100

Prefabricated ready-to-install kit, 3 m max., with upper and lower, pre-drilled mounting strips.

Cover : thickness 1.2 mm
Food-approved, brushed stainless steel (304 L).
Closed prefabricated welded end caps.

See photo page 40

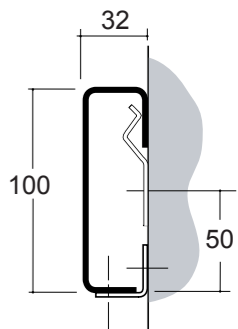

LLR-SS

Profile length: 3 m.
Food-approved, polished stainless steel (304 L).

Mounting accessories:

- Stainless steel mounting bracket with base plate
- Standard, external or internal end caps
- Splice plate

See photo pages 46 and 52

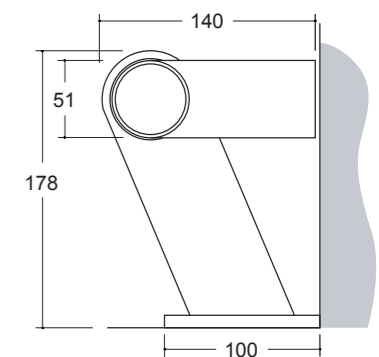

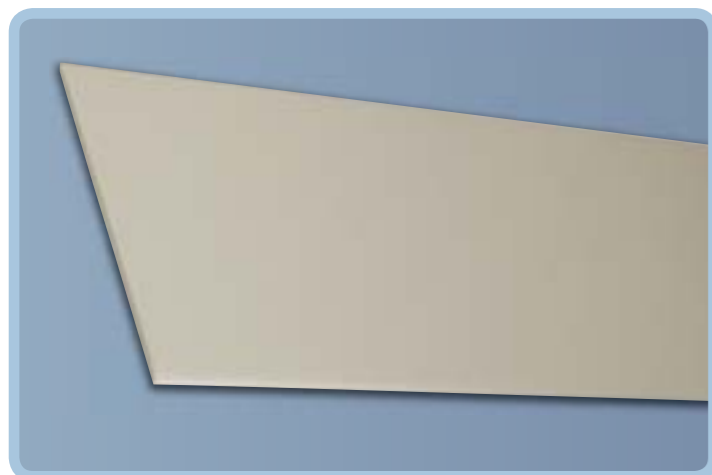

TP 300/200/150/100

Profile length: 4 m.

- TP 300 / 200 / 150 / 100 C/S Acrovyn® only.

Complementary accessories:

- External or internal corner 200 x 200 mm



Fire certification



C/S Acrovyn® Solid Standard Colours



See photo pages 20 and 22

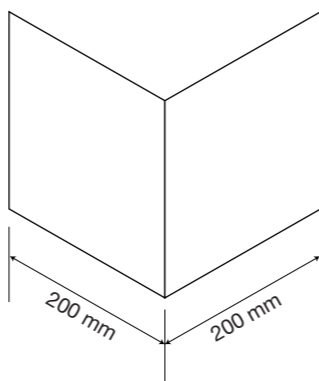

External or internal corner

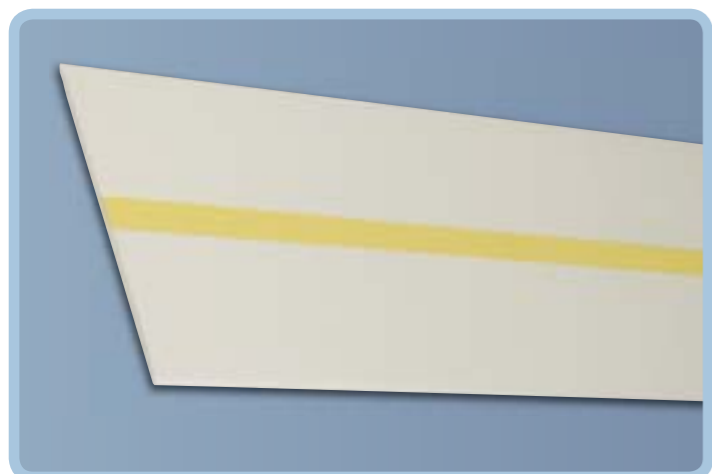
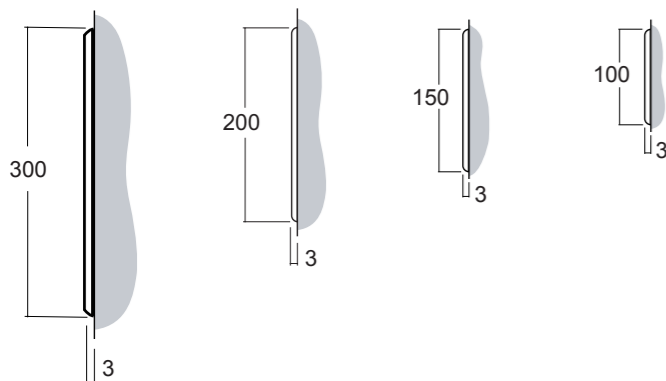

TP 200 DUO

Profile length: 4 m.

- TP 200 DUO C/S Acrovyn® only.

Complementary accessories:

- External or internal corner 200 x 200 mm



Fire certification



Duo Colour



See photo page 26

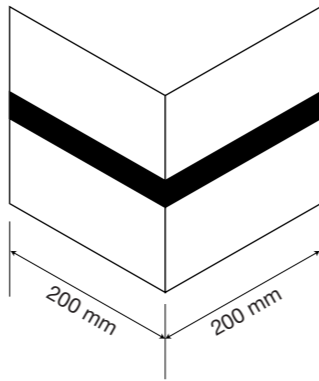

External or internal corner

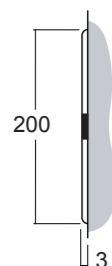

Surface mounted corner guards

SM 20

Profile length: 3 m.

Accessory:

- End cap



See photo page 46



Fire certification



C/S Acrovyn® Solid Standard Colours

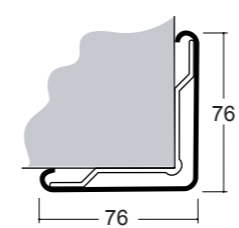

SSM 20

Profile length: 3 m.

Accessory:

- End cap



- C/S Acrovyn® Faux Wood
- C/S Acrovyn® Faux Brushed
- C/S Acrovyn® 3000 8 colours
- C/S Acrovyn® Faux Carbon

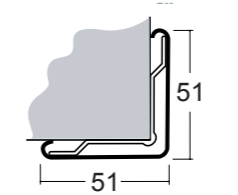

Fire certification



C/S Acrovyn® Solid Standard Colours



C/S Acrovyn® 3000 8 colours



Smoke certification

SM 20 M

Profile length: 3 m.

Accessory:

- End cap



See photo pages 24 and 32



Fire certification



C/S Acrovyn® Solid Standard Colours

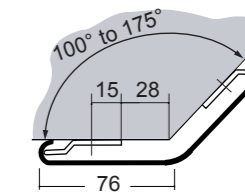

Stick-on corner guards

SO 75/50/30

Profile length: 3 m.

- SO 75/50/30 C/S Acrovyn® only.



See photo page 22



Fire certification



C/S Acrovyn® Solid Standard Colours

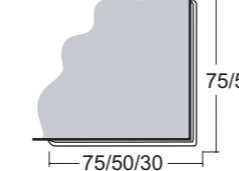

50A/40A/30A

Profile length: 3 m.

- Self-adhesive. Thickness 1 mm
- Food-approved, brushed stainless steel (304 L).



See photo page 40



Brushed stainless steel

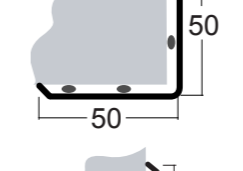

SO 50 V DUO

Profile length: 3 m.

- SO 50 V DUO C/S Acrovyn® only.



See photo page 26



Fire certification



Duo Colour

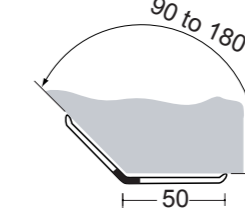

SO 50 V

Profile length: 3 m.

- SO 50 V C/S Acrovyn® only.



See photo pages 20 and 22



Fire certification



C/S Acrovyn® Solid Standard Colours

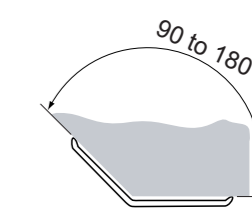

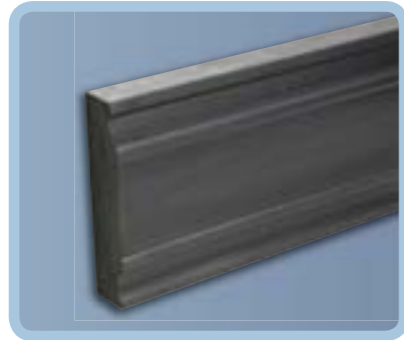

200 W 50
 Profile length: 3 m.
 Optional:
 Self-adhesive reflective insert.

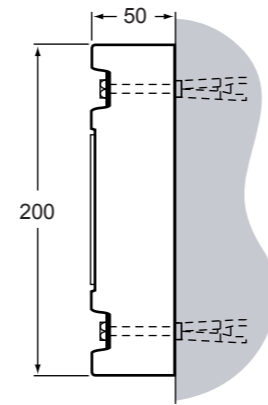

See photo page 50

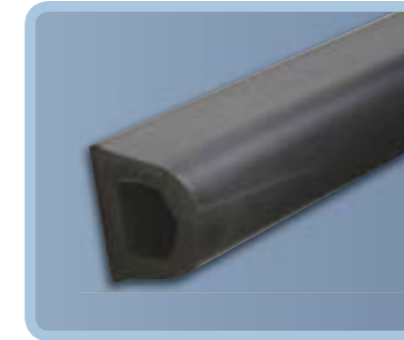

75 D
 Profile length: 3 m.
 Accessories:
 ■ Closing piece
 ■ Screw cap

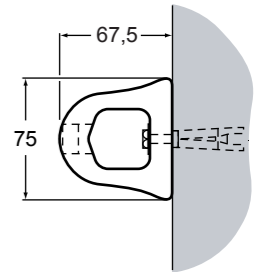

See photo page 50

200 W 30
 Profile length: 3 m.
 Optional:
 Self-adhesive reflective insert.

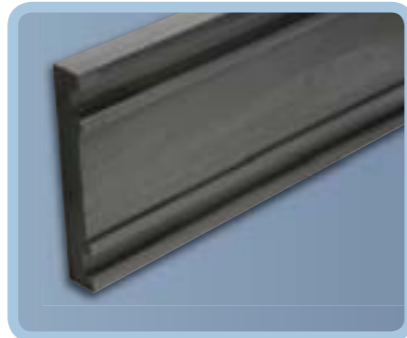

See photo page 50

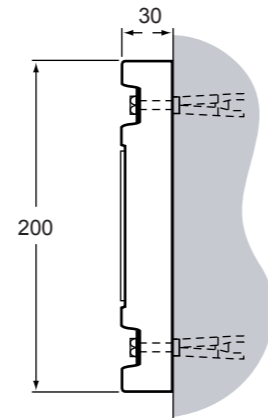

60 B
 Profile length: 3 m.
 Supplied with aluminium fastening strip.

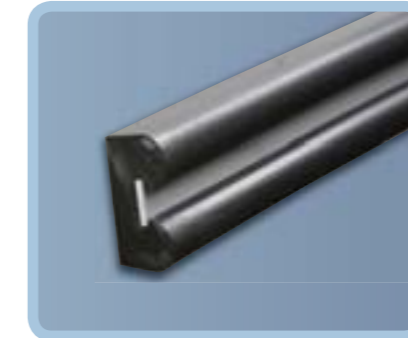

See photo page 50

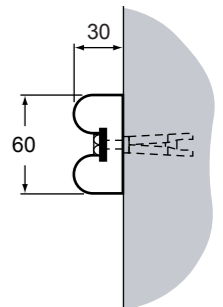

150 W 20
 Profile length: 3 m.
 Supplied with aluminium fastening strip
 and closing gasket

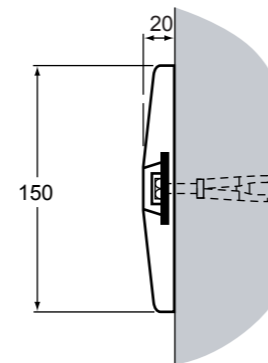

See photo page 50

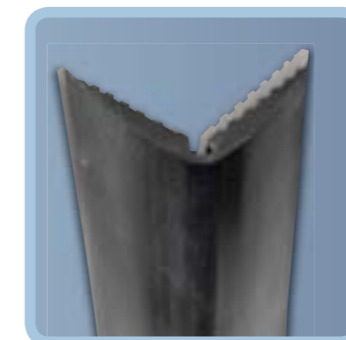

**Corner guards
 100 C**
 Profile length: 3 m.

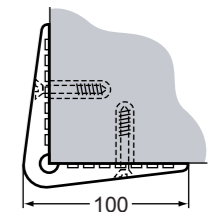

See photo page 50

100 D
 Profile length: 3 m.
 Accessories:
 ■ Closing piece
 ■ Screw cap

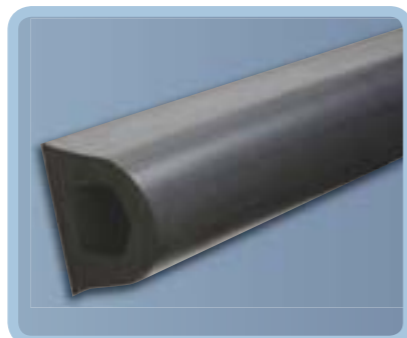

See photo page 50

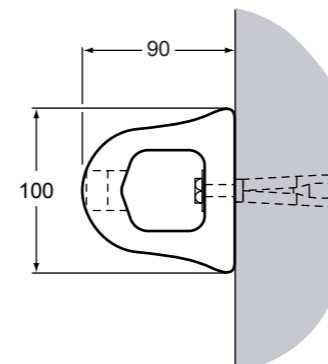

**Corner guards
 75 C**
 Profile length: 3 m.

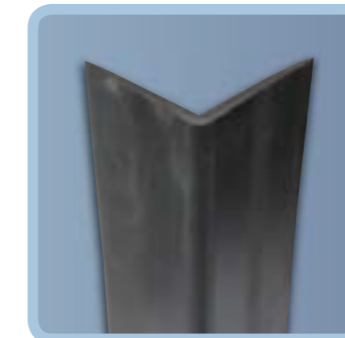

See photo page 50

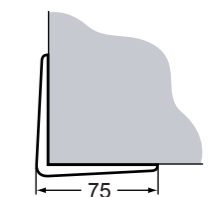



ACRO SERVICES™

Installation advice, services and solutions

Our installation partners are available on site and will work with you from project design until its successful completion.



Our installation partners will work with you from the preliminary study until the final installation.



OUR TEAMS MAKE YOUR LIFE SIMPLER:

Our Company representatives and installation partners provide you with expertise on the choice of products that meet your needs. Our sales representatives are also technically orientated, they are able to take the measurements on site and supply projects fully installed on a turn key basis.

TO HELP YOU SELECT THE RIGHT PRODUCT FOR YOUR PROJECT WE PROVIDE:

- **Specification texts** providing the detailed description for each product. These are available in paper or electronic format, or downloadable from our website.
 - **Colour selection charts and real product samples to confirm your choice.**
 - **On-line product guide for the right choice of products and colour visualizer at HYPERLINK «<http://www.cs-france.fr>» www.cs-france.fr or HYPERLINK «<http://www.c-sgroup.com>» www.c-sgroup.com** **EXCLUSIVE**
- The visualizer is an architectural framework which you can use to customize with product options and colours to create your own scheme.
- Our colour designer suggests 24 typical colour schemes to guide you in your choice.
- **Colour selection cards for the choice of colours:**
Printed card with 6 colour scheme options.

C/S France is the leading Interior Wall Protection Manufacturer in Europe

Even easier with...



Manufacturer

SERVICE + : MANUFACTURER

Our extrusion lines are at your service.

Project related production at required lengths : (reduction of material waste).

- Minimum of 150 metres for a specific production at project lengths.
- Production / Supply time ex works : approximately 4 to 5 weeks.
- Production tolerances of 20 to 40 mm in excess length



**Cut
to length**

SERVICE + : CUTTING

Our teams work for you.

We cut the products to the required length.

- Tolerances: +/- 1 mm



**Quick install
pre-fabrication**

SERVICE + : QUICK INSTALL

Delivery of prefabricated ready-to-install handrails.

- Reduced installation time.
- No cutting on site.
- Keeps costs under control.



Our products are designed for easy and rapid fitting

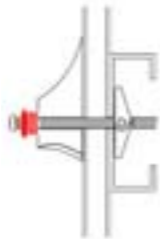

Fasten the mounting quick lock bracket to the wall.

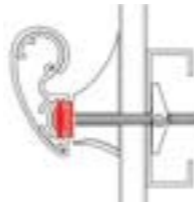

Position the handrail on the lock of the mounting bracket. Just give the lock a quarter turn to fasten the handrail.

DECISIVE ADVANTAGES FOR YOU!

In your workshop:

- Cutting to length.
- Fitting of profiles and end caps without drilling, screwing or riveting operations.
- The mounting of the end caps simply by a quarter turn with a spanner.

On site:

- Total freedom for the positioning of the mounting brackets on the wall.
- At the final phase of the installation, presentation of the pre-mounted elements and locking the quick lock mounting bracket by a mere quarter turn with a spanner.

Benefits:

- Cost reduction for the installation teams, reduced travelling expenses.
- Time optimization = **SAVINGS !**
- Final product installation at the end after all finishing works
- No risk of damage. No cleaning.
- Wall maintenance made easy by rapid removal and fitting.



Mounting of the standard end cap

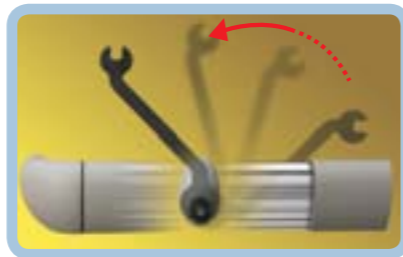

Without Quick Install
2 installers



With Quick Install
only 1 installer



EVERYTHING TO MAKE INSTALLATION EASIER

Required tools and adhesives are sold by the unit and are available from stock. Instructions are always attached to our products.

WELL-PREPARED SHIPMENTS

Our project orders are individually prepared and our products are packaged in plastic film protected cardboard boxes.

Delivery on pallet upon request

C/S FRANCE also means further architectural product solutions that you can discover on our websites: www.cs-france.fr



E-MAIL : marketing@cs-france.fr

MOBILITY AIDS - HANDRAILS

Handrails				
Ergonomic shape ▶	Textured		Smooth finish	
	Shape of Now	Traditional	Hygienic	
Material				
C/S Acrovyn	Solid Colours	HRB 20 (p. 68)	HRB 4C (p. 68)	MCE 40/45 (p. 69)
		HRB 35 (p. 68)		
		HR 06 (p. 69)		
		HR 06 (p. 69)		
Other materials	C/S Acrovyn 3000	HRB 20 (p. 68)	MCW 40/45 (p. 69)	ECR 32 A (p. 68)
		HR 06 (p. 69)		
		HR 06 (p. 69)		
				HRB 35 A (p. 68)
				MCE 40/45 A (p. 69)
				Vision (p. 69)

WALL PROTECTION PROFILES

Bumper guards				
Ergonomic shape ▶	Textured		Smooth finish	
	Shape of Now	Traditional	Hygienic	
Material				
C/S Acrovyn	Solid Colours	SCR 80M (p. 70)	TP 300 (p. 72)	ARONDE 170 (p. 70)
		SCR 50M (p. 70)		
		FR 225 (p. 70)		
		TP 200 (p. 72)		
Other materials	C/S Acrovyn 3000	SCR 80M (p. 70)	TP 150 (p. 72)	TP 100 (p. 72)
		SCR 80M (p. 70)		
		SCR 80M (p. 70)		
				CRS 200 (p. 71)
				CRS 150 (p. 71)
				CRS 100 (p. 71)
				LLR-SS (p. 71)

Corner guards				
Ergonomic shape ▶	Textured		Smooth finish	
	Shape of Now	Traditional	Hygienic	
Material				
C/S Acrovyn	Solid Colours	SO 75 (p. 73)	SM 20 (p. 73)	Stick On
		SO 50 (p. 73)		
		SO 30 (p. 73)		
		SO 50V (p. 73)		
Other materials	C/S Acrovyn 3000	SM 20 (p. 73)	SSM 20 (p. 73)	Stick On
		SM 20 (p. 73)		
		SM 20 (p. 73)		
				50 A (p. 73)
				40 A (p. 73)
				30 A (p. 73)

Protection and Design: C/S Acrovyn® sheets for Wall and Door Protection

Material	Thickness	Textured	Smooth finish
C/S Acrovyn	Solid Colours	2 mm (p. 59 to 67)	6 colours
	Solid Colours	0.8 mm (p. 59 to 67)	30 colours
	Faux Wood	2 mm (p. 59 to 67)	5 Woodgrains
	Faux Brushed Silver	2 mm (p. 59 to 67)	Brushed Silver
Other materials	C/S Acrovyn 3000	2 mm (p. 59 to 67)	Carbon
		1.5 mm (p. 59 to 67)	8 colours

INDUSTRIAL PROTECTION

C/S Stelatex		
Material	Bumper guard	Corner guard
Elastomer	EPDM	200 W 50 (p. 74)
		200 W 30 (p. 74)
		150 W 20 (p. 74)
		100 D (p. 74)
		75 D (p. 75)
		60 B (p. 75)
Neoprene		100 C (p. 75)
		75 C (p. 75)

Material and colour selection chart

C/S ACROVYN®

30 C/S Acrovyn® Solid Standard Colours

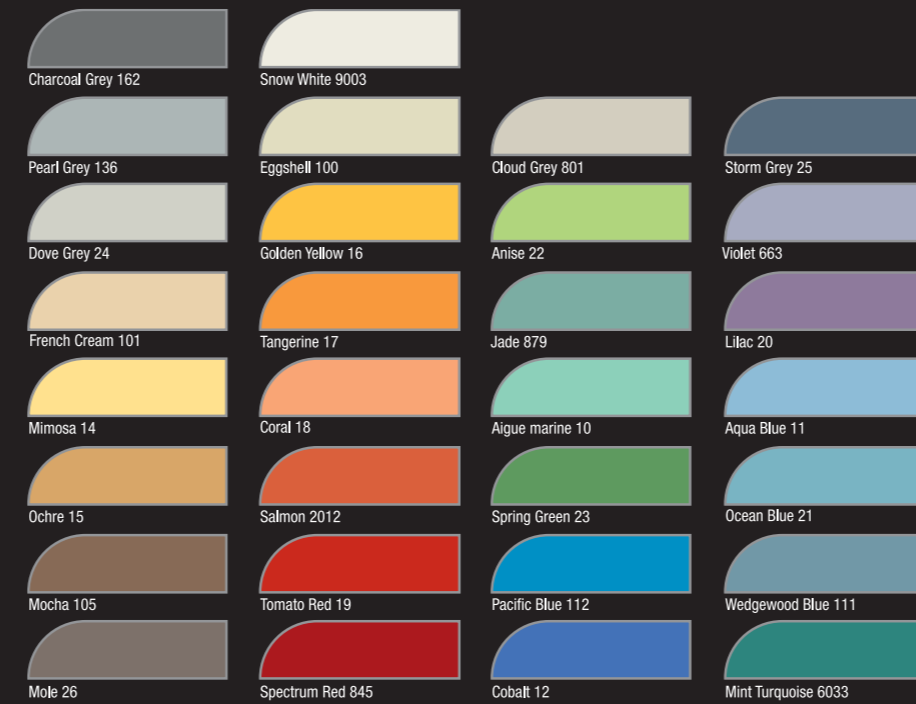

5 Standard Colours for the Vision Handrail



2 x 5 DUO Colour combinations

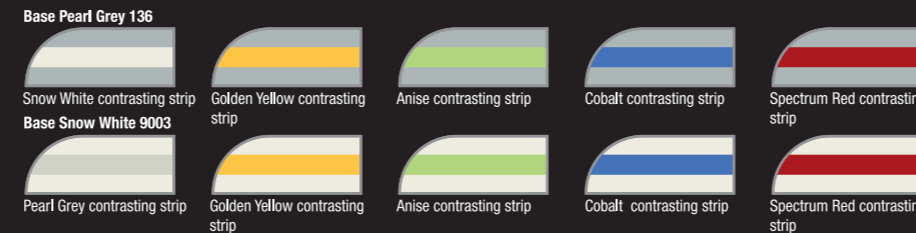

6 C/S Acrovyn® Solid Standard Colours for smooth hygienic sheets

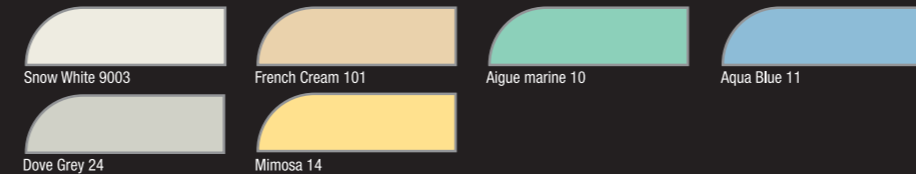

5 C/S Acrovyn® Faux Woodgrains

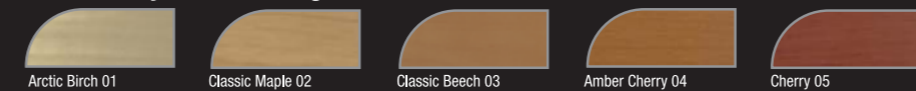

C/S Acrovyn® Faux Brushed Silver



C/S Acrovyn® Faux Carbon

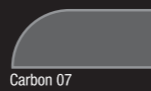

The printed document does not guarantee true colour reproduction. It is therefore recommended to choose from real product samples.

8 C/S Acrovyn® 3000 Standard Solid Colours

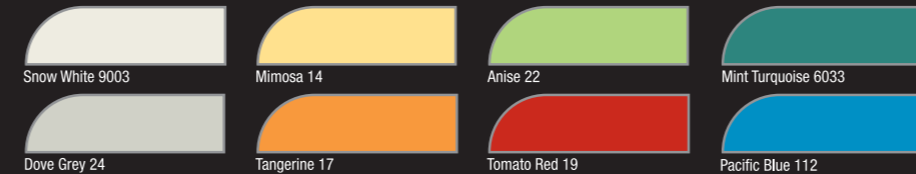

C/S FRANCE
135, rue Edouard Isambard
B.P. 66
27120 Pacy-sur-Eure Cedex
FRANCE

Tél. : 00 33 (0)2 32 67 00 00

Fax : 00 33 (0)2 32 67 14 12

Website: www.cs-france.fr

www.c-sgroup.com

E-mail: marketing@cs-france.fr

FROM PARIS BY MOTORWAY A 13: EXIT 15 (C/S France 8 km)
OR FROM ROUEN BY MOTORWAY A 13: EXIT 16 (C/S France 6 km)

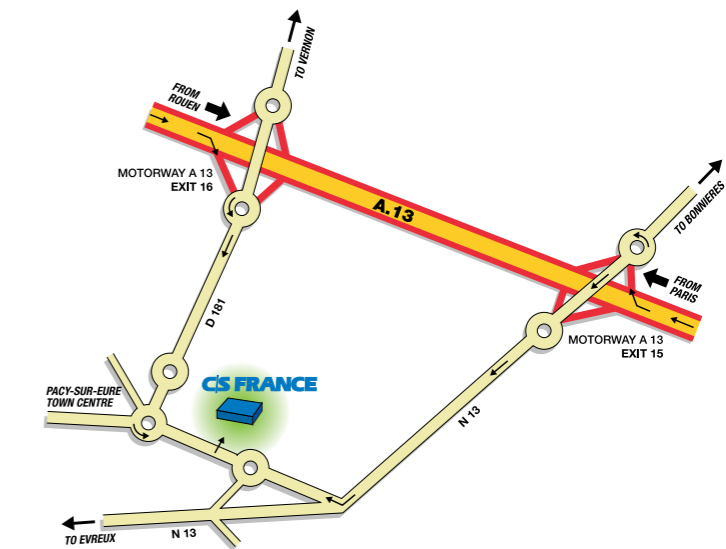

C/S FRANCE
135, rue Edouard Isambard
B.P. 66
27120 Pacy-sur-Eure Cedex
FRANCE

Tel. : 00 33 (0)2 32 67 00 00

Fax : 00 33 (0)2 32 67 14 12

Website: www.cs-france.fr

www.c-sgroup.com

E-mail: marketing@cs-france.fr

USA - CANADA - HONG-KONG - SINGAPORE - AUSTRALIA - EUROPE

CS Construction Specialties

worldwide

COUVRANEUF



Expansion joint covers systems

C/S ACROVYN®



Wall, corner and door protection

C/S PEDISYSTEMS



Entrance flooring systems

WATTOHM



Technical profiles and plastic tubes

WATTOLENE



Extruded polystyrene sheets

LUMISYSTEMS



Lighting appliances

C/S AIRFOIL



Sun controls